

NICHE®
FOR A BETTER US

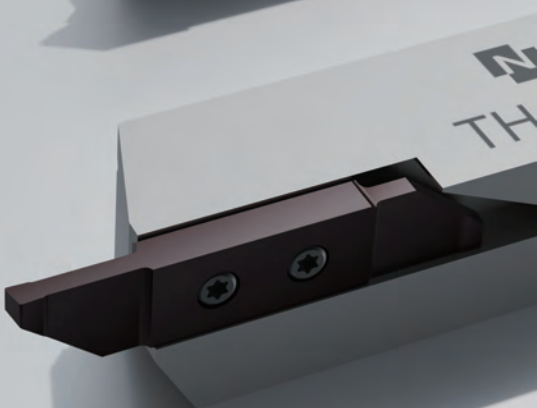

www.niche-tool.com

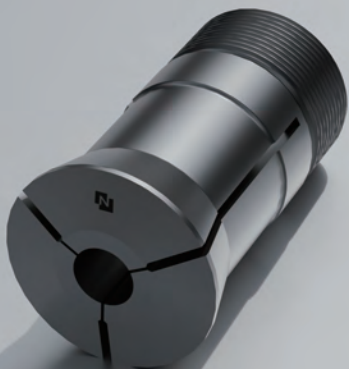
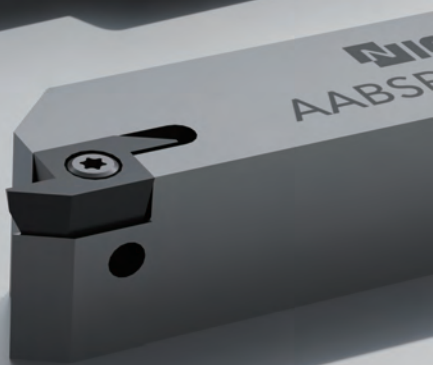
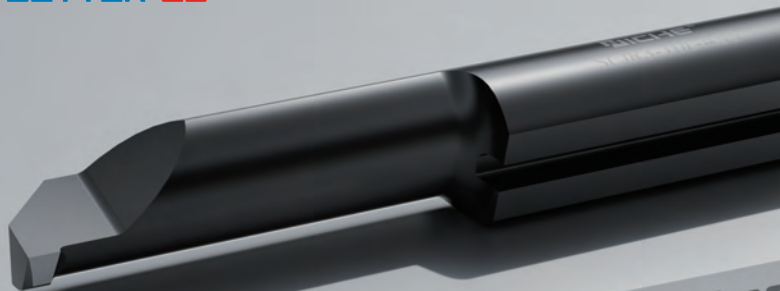

INDEX

Code Key - ISO Turning Holders	01
Code Key - ISO Inserts	04
External Toolholders SCLC	05
External Toolholders SCLC-FF	06
External Toolholders S-SCLC	07
ISO Turning Inserts CC**	08
External Toolholders SDJC	10
External Toolholders SDJC-FF	11
External Toolholders SDJC-FF-Y	12
External Toolholders S-SDLC	13
External Toolholders S-SDUC	14
ISO Turning Inserts DC**	15
External Toolholders STGC	17
ISO Turning Inserts TC**	18
External Toolholders SVJB	19
External Toolholders SVJB-FF	20
External Toolholders SVVB	21
External Toolholders S-SVUB	22
ISO Turning Inserts VB**	23
External Toolholders SVJC-FF	24
External Toolholders S-SVUC	25

INDEX

ISO Turning Inserts VC**	26
Recommended Cutting Data External turning	28
Toolholders For Back Turning SABS-40F	30
Turning Indexable Inserts ABS**	31
Toolholders For Back Turning SABW-40F	32
Toolholders For Back Turning SABW-50F	33
Turning Indexable Inserts ABW**	34
Recommended Cutting Data ABS15, ABW15	35
Code Key - TKF / TKFB	36
Toolholders For Back Turning KTKF	38
Toolholders For Back Turning KTKF-Y	39
Turning Indexable Inserts TKFB	40
Small Diameter Cut-off KTKF Cutting off	41
Small Diameter Cut-off KTKF-S	42
Small Diameter Cut-off KTKF Goose-neck holder	43
Small Diameter Cut-off KTKF Y-axis toolholder	43
Small Diameter Insert - TKF12	44
Multipurpose Threading Tools KTKF	46
Multipurpose Threading Inserts TKFT	48
Recommended Cutting Data - Threading	50
Code Key - THC	52

INDEX

Parting-off Tools THC42	53
Parting-off Insert THC42	54
Code Key - KGT/MGT	55
Available tool holders KGEHR/L	57
Auto Tools Insert KGT	58
Recommended Cutting Data Auto Tools	59
Mini Turn For Small Parts Machining S-SVN-N	60
Mini Turn For Small Parts Machining S-SVN-SN	61
Mini Turn For Small Parts Machining SVN-N	62
Mini Turn For Small Parts Machining SVNS-N	63
Turning Indexable Inserts VNB	64
Turning Indexable Inserts VNB-S	65
Turning Indexable Inserts VNB-NB	66
Mini Turn For Small Parts Machining VNBT	67
Mini Turn For Small Parts Machining SVNS-XN	68
Mini Turn For Small Parts Machining S-SVN-XN	69
Mini Turn For Small Parts Machining S-SVN-SXN	70
Turning Indexable Inserts VNBX-S	71
Recommended Cutting Data VNB	72
Code Key Micro-tools For Boring	74
Solid Cutting Tools For Micro Machining SCNR	75

INDEX

Solid Cutting Tools For Micro Machining SCTR	77
Solid Cutting Tools For Micro Machining SCPR	79
Solid Cutting Tools For Micro Machining SCQR	81
Solid Cutting Tools For Micro Machining SCWR	83
Solid Cutting Tools For Micro Machining SCFL	84
Solid Cutting Tools For Micro Machining SCFR	85
Solid Cutting Tools For Micro Machining SCIR	86
Solid Cutting Tools For Micro Machining XSHB	88



Code Key - ISO Turning Holders

External Turning Tools

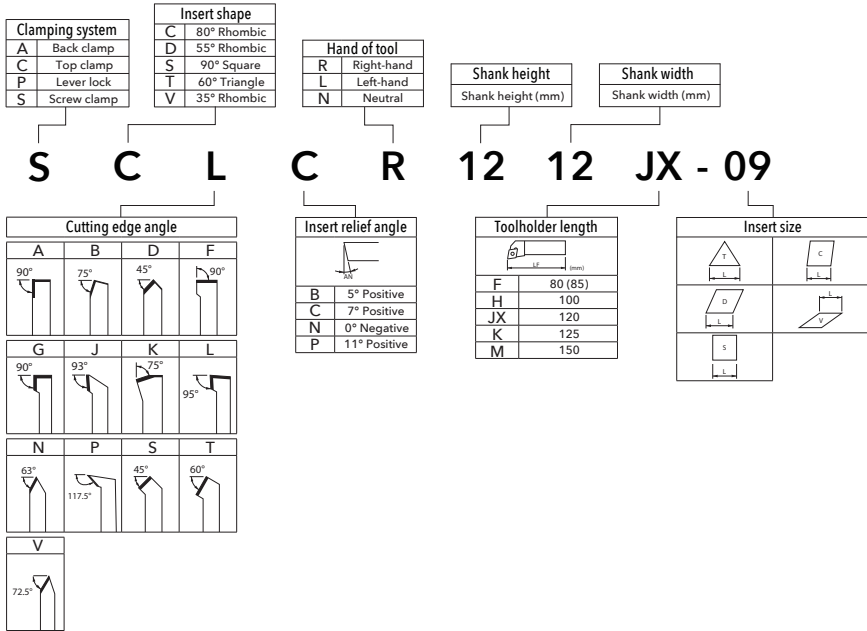

Internal Boring Bars

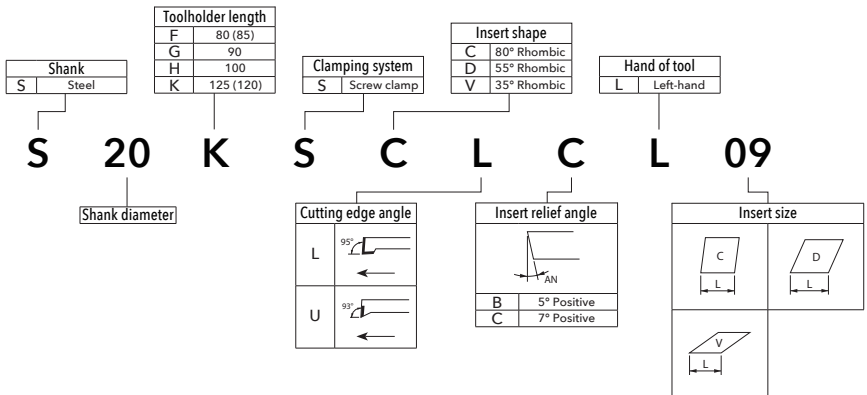



(1) CNC Automatic lathe (Gang Type)

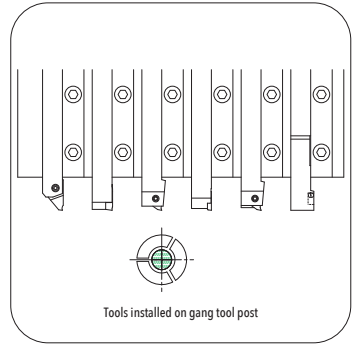
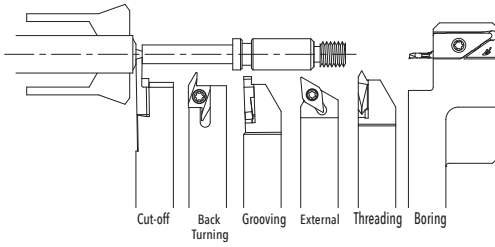

(2) CNC Automatic lathe (Gang Type)

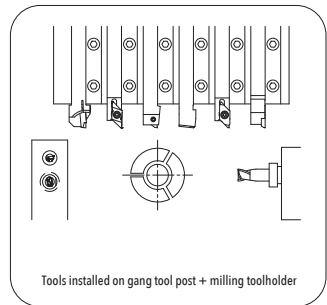
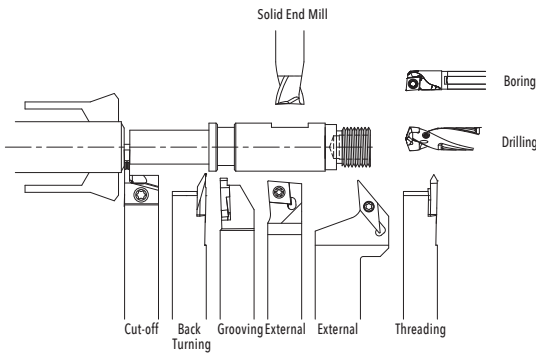



Code Key - ISO Turning Holders

(3) CNC Automatic lathe (Opposed Gang Type)

External / Facing

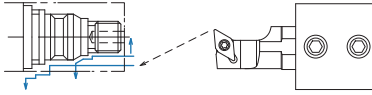

External / Copying

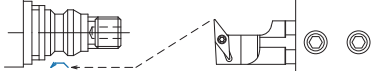

Grooving

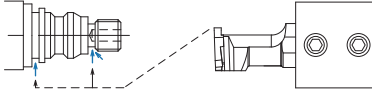

Threading

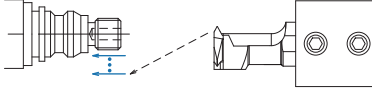

Boring

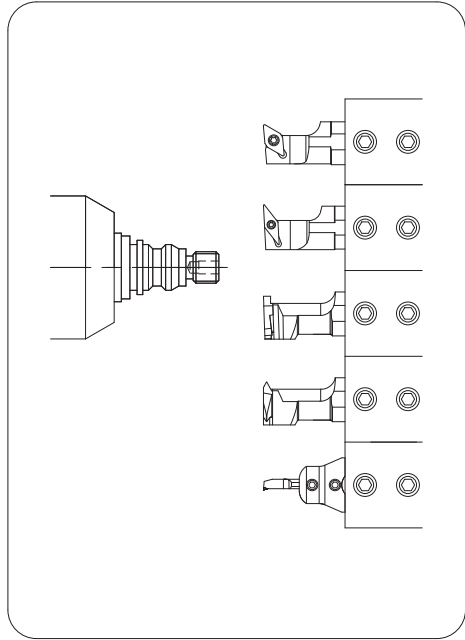
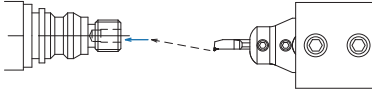

(4)

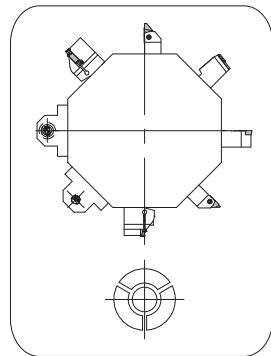
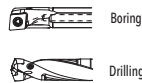
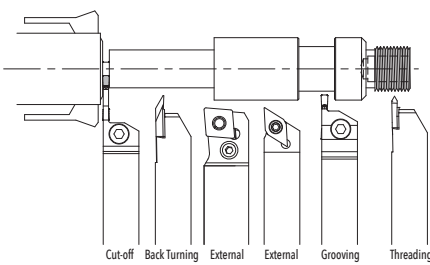



Code system (ISO type)

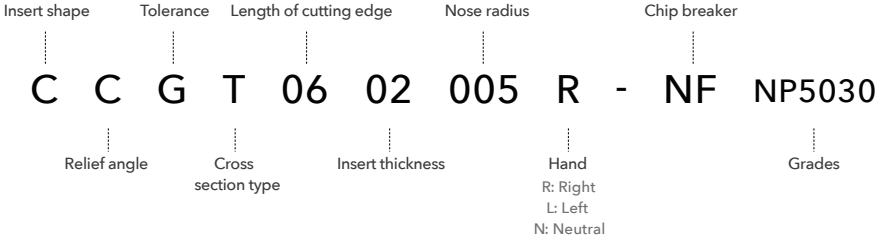

Nose R (Tolerance of Corner R)

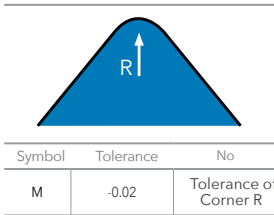

Hand of insert

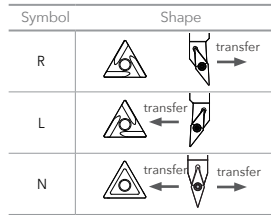

NF (E & G class tolerance)



- For finishing
- Low cutting loads with sharp cutting edges
- Longer tool life due to lower chip evacuation resistance at high speed
- Excellent surface roughness

NM (E & G class tolerance)



- For medium cutting to finishing
- Better chip flow due to wide chip pockets
- Longer tool life and better cutting action due to improved chip evacuation
- Excellent surface roughness

NM1 (G class tolerance)



- Finish and medium machining
- Sharp edges for low cutting load and low cutting heat
- Wide range machining
- Smooth and stable chip evacuation

MS (G class tolerance)



- Sharp cutting edges for medium cutting
- Less built-up edge in Titanium machining
- Better chip evacuation in high feed machining
- Shape for good chip control protects cutting edge.



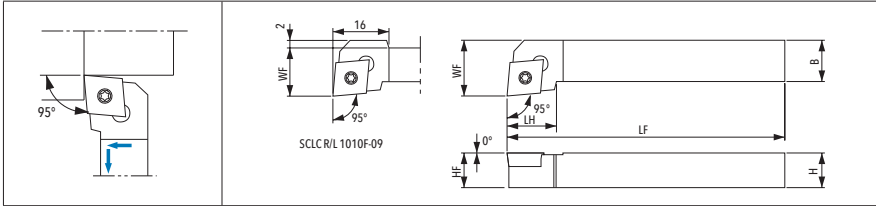

SCLC

External turning / External facing, Screw clamp



Right-hand shown

Unit: mm

Specification	Dimensions						Screw 	Wrench 	Insert	Std. R
	H	B	LH	HF	LF	WF				
SCLCR/L1010F06	10	10	9	10	80	12	SB2570TR	T8	CC**0602...	0.2
SCLCR/L1010F09	10	10	14	10	80	14	SB4085TR	T15	CC**09T3...	0.2
SCLCR/L1212H09	12	12	14	12	100	16	SB4085TR	T15	CC**09T3...	0.2
SCLCR/L1616H09	16	16	15	16	100	20	SB4085TR	T15	CC**09T3...	0.2
SCLCR/L2020K09	20	20	20	20	125	25	SB4085TR	T15	CC**09T3...	0.2
SCLCR/L2525M09	25	25	22	25	150	32	SB4085TR	T15	CC**09T3...	0.2

Insert see page 08-09





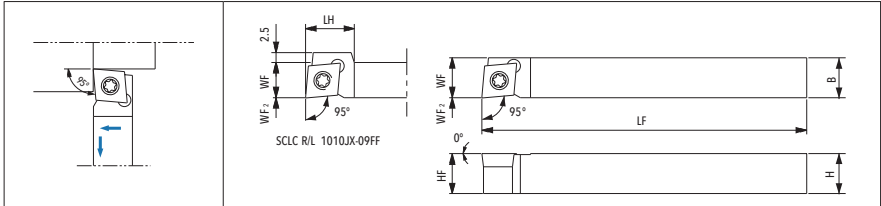

SCLC-FF

External turning / External facing, Screw clamp, Without offset



Right-hand shown

Unit: mm

Specification	Dimensions							Screw 	Wrench 	Insert	Std.R
	H	B	LH	HF	LF	WF	WF2				
SCLCR/L0808F06FF	8	8	-	8	85	8	0	SB2570TR	T8	CC**0602...	0.2
SCLCR/L1010JX06FF	10	10	-	10	120	10	0	SB2570TR	T8	CC**0602...	0.2
SCLCR/L1010JX09FF	10	10	15	10	120	10	0	SB4085TR	T15	CC**09T3...	0.2
SCLCR/L1212F09FF	12	12	-	12	85	12	0	SB4085TR	T15	CC**09T3...	0.2
SCLCR/L1212JX09FF	12	12	-	12	120	12	0	SB4085TR	T15	CC**09T3...	0.2
SCLCR/L1616JX09FF	16	16	-	16	120	16	0	SB4085TR	T15	CC**09T3...	0.2
SCLCR/L2020JX09FF	20	20	-	20	120	20	0	SB4085TR	T15	CC**09T3...	0.2

Insert see page 08-09 



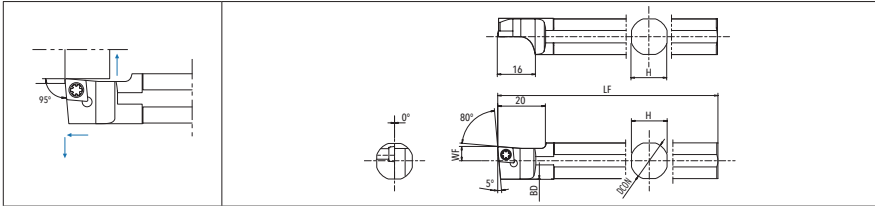

S-SCLC

External turning / External facing



Left-hand shown | Right-hand Insert for Left-hand Toolholder.

Unit: mm

Specification	Dimensions					Screw 	Wrench 	Insert	Std. R
	H	B	HF	LF	WF				
S12F-SCLCL06	12	11	13.4	80	6	SB2560TR	T8	CC**0602...	0.4
S14H-SCLCL06	14	13	13.4	100	6	SB2560TR	T8	CC**0602...	0.4
S15F-SCLCL06	15.875	15	15.4	85	6	SB2570TR	T8	CC**0602...	0.4
S16F-SCLCL06	16	15	15.4	85	6	SB2570TR	T8	CC**0602...	0.4
S19G-SCLCL06	19.05	17	18.4	90	6	SB2570TR	T8	CC**0602...	0.4
S19K-SCLCL06	19.05	17	18.4	120	6	SB2570TR	T8	CC**0602...	0.4
S20G-SCLCL06	20	18	19.4	90	6	SB2570TR	T8	CC**0602...	0.4
S20K-SCLCL06	20	18	19.4	120	6	SB2570TR	T8	CC**0602...	0.4
S19G-SCLCL09	19.05	17	18.4	90	10	SB4065TR	T15	CC**09T3...	0.4
S19K-SCLCL09	19.05	17	18.4	120	10	SB4065TR	T15	CC**09T3...	0.4
S20G-SCLCL09	20	18	19.4	90	10	SB4065TR	T15	CC**09T3...	0.4
S20K-SCLCL09	20	18	19.4	120	10	SB4065TR	T15	CC**09T3...	0.4
S25H-SCLCL09	25	23	24.4	100	10	SB4065TR	T15	CC**09T3...	0.4
S25K-SCLCL09	25.4	23	24.8	120	10	SB4065TR	T15	CC**09T3...	0.4

Insert see page 08-09





CC**

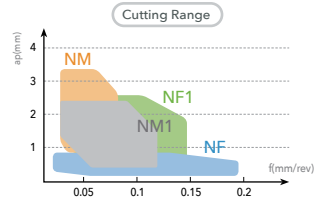
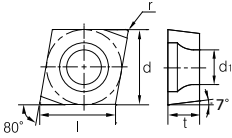

Specification	Dimensions					Coated			Uncoated
	l	Ød	t	r	Ød1	NP5030	NP9030	NP1030	NU8000
CCGT0602005R-NM	6.6	6.35	2.38	0.05	2.8	•	•	•	•
CCGT060201R-NM	6.4	6.35	2.38	0.1	2.8	•	•	•	•
CCGT060202R-NM	6.2	6.35	2.38	0.2	2.8	•	•	•	•
CCGT09T3005R-NM	9.8	9.525	3.97	0.05	4.4	•	•	•	•
CCGT09T301R-NM	9.6	9.525	3.97	0.1	4.4	•	•	•	•
CCGT09T302R-NM	9.2	9.525	3.97	0.2	4.4	•	•	•	•
CCGT0602005L-NM	6.6	6.35	2.38	0.05	2.8	•	•	•	•
CCGT060201L-NM	6.4	6.35	2.38	0.1	2.8	•	•	•	•
CCGT060202L-NM	6.2	6.35	2.38	0.2	2.8	•	•	•	•
CCGT09T3005L-NM	9.8	9.525	3.97	0.05	4.4	•	•	•	•
CCGT09T301L-NM	9.6	9.525	3.97	0.1	4.4	•	•	•	•
CCGT09T302L-NM	9.2	9.525	3.97	0.2	4.4	•	•	•	•
CCGT0602005R-NF	6.6	6.35	2.38	0.05	2.8	•	•	•	•
CCGT060201R-NF	6.4	6.35	2.38	0.1	2.8	•	•	•	•
CCGT060202R-NF	6.2	6.35	2.38	0.2	2.8	•	•	•	•
CCGT09T3005R-NF	9.8	9.525	3.97	0.05	4.4	•	•	•	•
CCGT09T301R-NF	9.6	9.525	3.97	0.1	4.4	•	•	•	•
CCGT09T302R-NF	9.2	9.525	3.97	0.2	4.4	•	•	•	•
CCGT0602005L-NF	6.6	6.35	2.38	0.05	2.8	•	•	•	•
CCGT060201L-NF	6.4	6.35	2.38	0.1	2.8	•	•	•	•
CCGT060202L-NF	6.2	6.35	2.38	0.2	2.8	•	•	•	•
CCGT09T3005L-NF	9.8	9.525	3.97	0.05	4.4	•	•	•	•
CCGT09T301L-NF	9.6	9.525	3.97	0.1	4.4	•	•	•	•
CCGT09T302L-NF	9.2	9.525	3.97	0.2	4.4	•	•	•	•

Recommended cutting data see page 28-29



ISO Turning Inserts

CC**

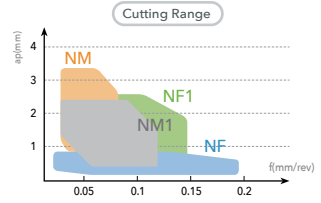
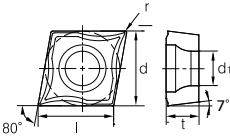

Unit: mm

Specification	Dimensions					Coated			Uncoated
	l	Ød	t	r	Ød1	NP5030	NP9030	NP1030	NU8000
CCGT60201-NF1	6.6	6.35	2.38	0.1	2.8	●	●	●	●
CCGT60202-NF1	6.4	6.35	2.38	0.2	2.8	●	●	●	●
CCGT60204-NF1	6.2	6.35	2.38	0.4	2.8	●	●	●	●
CCGT09T301-NF1	9.8	9.525	3.97	0.1	4.4	●	●	●	●
CCGT09T302-NF1	9.6	9.525	3.97	0.2	4.4	●	●	●	●
CCGT09T304-NF1	9.2	9.525	3.97	0.4	4.4	●	●	●	●

Recommended cutting data see page 28-29



SDJC

External turning / External copying, Screw clamp

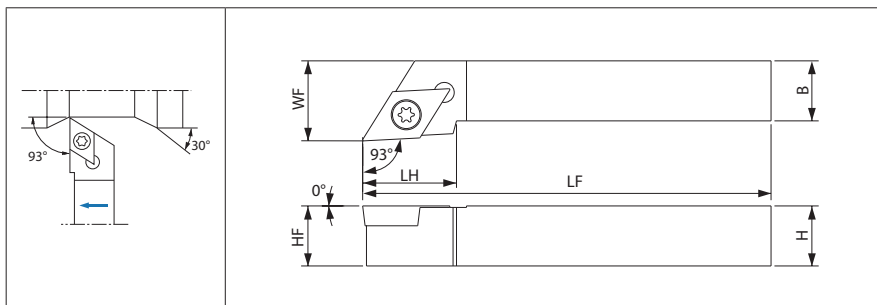

Right-hand shown

Unit: mm

Specification	Dimensions						Screw	Wrench	Insert	Std.R
	H	B	LH	HF	LF	WF				
SDJCR/L1010F07	10	10	12	10	80	12	SB2570TR	T8	DC**0702...	0.2
SDJCR/L1010F11	10	10	18	10	80	12	SB4085TR	T15	DC**11T3...	0.2
SDJCR/L1212H11	12	12	18	12	100	16	SB4085TR	T15	DC**11T3...	0.2
SDJCR/L1616H11	16	16	18	16	100	20	SB4085TR	T15	DC**11T3...	0.2
SDJCR/L2020K11	20	20	18	20	125	25	SB4085TR	T15	DC**11T3...	0.2
SDJCR/L2525M11	25	25	23	25	150	32	SB4085TR	T15	DC**11T3...	0.2

Insert see page 15-16



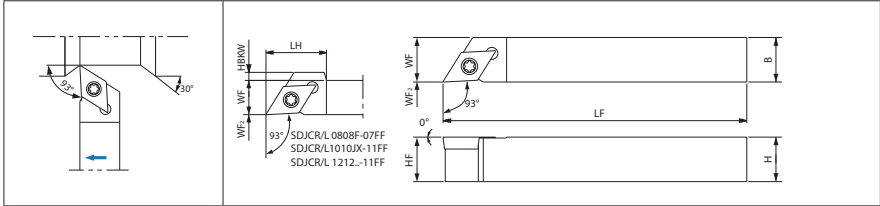

SDJC-FF

External turning / External copying, Screw clamp, Without offset



Right-hand shown

Unit: mm

Specification	Dimensions								Screw 	Wrench 	Insert	Std.R
	H	B	LH	HF	HBKW	LF	WF	WF2				
SDJCR/L0808F07FF	8	8	14	8	0.5	85	8	0	SB2570TR	T8	DC**0702...	0.2
SDJCR/L1010JX07FF	10	10	-	10	-	120	10	0	SB2570TR	T8	DC**0702...	0.2
SDJCR/L1010JX11FF	10	10	20	10	3	120	10	0	SB4085TR	T15	DC**11T3...	0.2
SDJCR/L1212F11FF	12	12	20	12	1	85	12	0	SB4085TR	T15	DC**11T3...	0.2
SDJCR/L1212JX11FF	12	12	20	12	1	120	12	0	SB4085TR	T15	DC**11T3...	0.2
SDJCR/L1616JX11FF	16	16	-	16	-	120	16	0	SB4085TR	T15	DC**11T3...	0.2
SDJCR/L2020JX11FF	20	20	-	20	-	120	20	0	SB4085TR	T15	DC**11T3...	0.2

Insert see page 15-16





SDJC-FF-Y

External turning / External copying, Y-axis toolholder

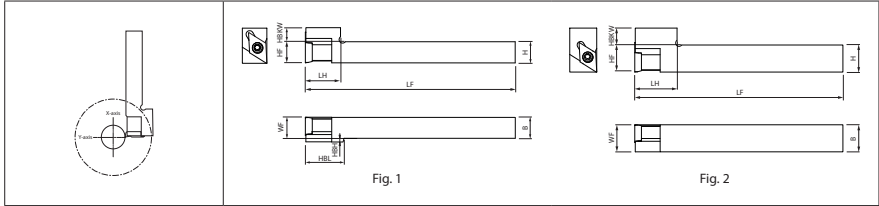

Right-hand shown | Right-hand Insert for Right-hand Toolholder.

Unit: mm

Specification	Dimensions									Fig.	Screw	Wrench	Insert
	H	B	LH	HF	HBH	HBKW	HBL	LF	WF				
SDJCR1212JX11FFY	12	12	20	12	2	8	22	120	12	1	SB4585TR	T15	DC**11T3...
SDJCR1616JX11FFY	16	16	25	16	-	10	-	120	16	2	SB4585TR	T15	DC**11T3...

Insert see page 15-16



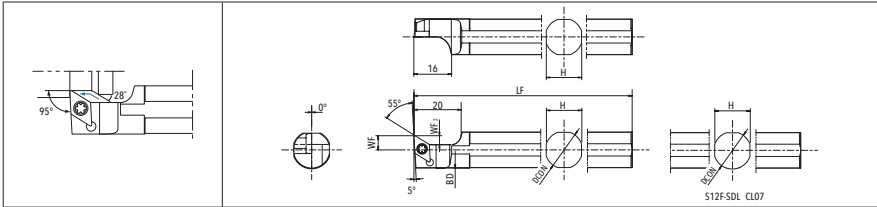

S-SDLC

External turning / External copying



Left-hand shown | Right-hand Insert for Left-hand Toolholder.

Unit: mm

Specification	Dimensions						Screw 	Wrench 	Insert	Std.R
	H	B	HF	LF	WF	WF2				
S12F-SDLCCL07	12	11	13.4	80	6	3.8	SB2560TR	T8	DC**0702...	0.4
S14H-SDLCCL07	14	13	13.4	100	6	3.8	SB2560TR	T8	DC**0702...	0.4
S15F-SDLCCL07	15.875	15	15.4	85	6	3.8	SB2560TR	T8	DC**0702...	0.4
S16F-SDLCCL07	16	15	15.4	85	6	3.8	SB2560TR	T8	DC**0702...	0.4
S19G-SDLCCL07	19.05	17	18.4	90	6	3.8	SB2560TR	T8	DC**0702...	0.4
S19K-SDLCCL07	19.05	17	18.4	120	6	3.8	SB2560TR	T8	DC**0702...	0.4
S20G-SDLCCL07	20	18	19.4	90	6	3.8	SB2560TR	T8	DC**0702...	0.4
S20K-SDLCCL07	20	18	19.4	120	6	3.8	SB2560TR	T8	DC**0702...	0.4
S19G-SDLCCL11	19.05	17	18.4	90	10	5.8	SB4085TR	T15	DC**11T3...	0.4
S19K-SDLCCL11	19.05	17	18.4	120	10	5.8	SB4085TR	T15	DC**11T3...	0.4
S20G-SDLCCL11	20	18	19.4	90	10	5.8	SB4085TR	T15	DC**11T3...	0.4
S20K-SDLCCL11	20	18	19.4	120	10	5.8	SB4085TR	T15	DC**11T3...	0.4
S22K-SDLCCL11	22	20	21.4	120	10	5.8	SB4085TR	T15	DC**11T3...	0.4
S25H-SDLCCL11	25	23	24.4	100	10	5.8	SB4085TR	T15	DC**11T3...	0.4
S25K-SDLCCL11	25.4	23	24.8	120	10	5.8	SB4085TR	T15	DC**11T3...	0.4

Insert see page 15-16





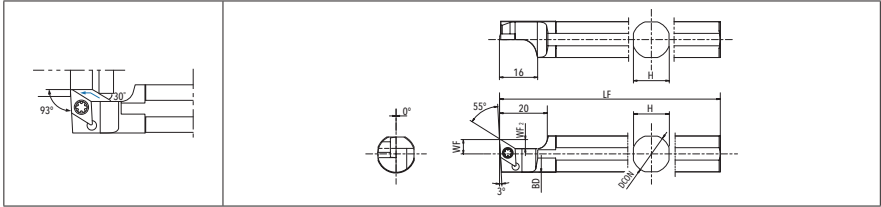

S-SDUC

External turning / External copying



Left-hand shown | Right-hand Insert for Left-hand Toolholder.

Unit: mm

Specification	Dimensions						Screw 	Wrench 	Insert	Std.R
	H	B	HF	LF	WF	WF2				
S14H-SDUCL07	14	13	13.4	100	6	3.8	SB2560TR	T8	DC**0702...	0.4
S15F-SDUCL07	15.875	15	15.4	85	6	3.8	SB2560TR	T8	DC**0702...	0.4
S19G-SDUCL07	19.05	17	18.4	90	6	3.8	SB2560TR	T8	DC**0702...	0.4
S19K-SDUCL07	19.05	17	18.4	120	6	3.8	SB2560TR	T8	DC**0702...	0.4
S20G-SDUCL07	20	18	19.4	90	6	3.8	SB2560TR	T8	DC**0702...	0.4
S20K-SDUCL07	20	18	19.4	120	6	3.8	SB2560TR	T8	DC**0702...	0.4
S19G-SDUCL11	19.05	17	18.4	90	10	5.8	SB4085TR	T15	DC**11T3...	0.4
S19K-SDUCL11	19.05	17	18.4	120	10	5.8	SB4085TR	T15	DC**11T3...	0.4
S20G-SDUCL11	20	18	19.4	90	10	5.8	SB4085TR	T15	DC**11T3...	0.4
S20K-SDUCL11	20	18	19.4	120	10	5.8	SB4085TR	T15	DC**11T3...	0.4
S22K-SDUCL11	22	20	21.4	120	10	5.8	SB4085TR	T15	DC**11T3...	0.4
S25H-SDUCL11	25	23	24.4	100	10	5.8	SB4085TR	T15	DC**11T3...	0.4
S25K-SDUCL11	25.4	23	24.8	120	10	5.8	SB4085TR	T15	DC**11T3...	0.4

Insert see page 15-16 



ISO Turning Inserts

DC**

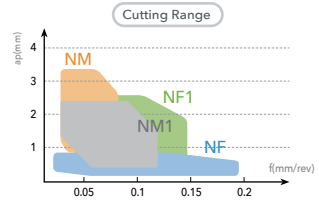
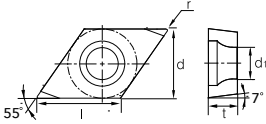

Unit: mm

Specification	Dimensions					Coated			Uncoated
	l	Ød	t	r	Ød1	NP5030	NP9030	NP1030	NU8000
DCGT0702005R-NM	7.8	6.35	2.38	0.05	2.8	●	●	●	●
DCGT070201R-NM	7.8	6.35	2.38	0.1	2.8	●	●	●	●
DCGT070202R-NM	7.8	6.35	2.38	0.2	2.8	●	●	●	●
DCGT11T3005R-NM	11.6	9.525	3.97	0.05	4.4	●	●	●	●
DCGT11T301R-NM	11.6	9.525	3.97	0.1	4.4	●	●	●	●
DCGT11T302R-NM	11.6	9.525	3.97	0.2	4.4	●	●	●	●
DCGT0702005L-NM	7.8	6.35	2.38	0.05	2.8	●	●	●	●
DCGT070201L-NM	7.8	6.35	2.38	0.1	2.8	●	●	●	●
DCGT070202L-NM	7.8	6.35	2.38	0.2	2.8	●	●	●	●
DCGT11T3005L-NM	11.6	9.525	3.97	0.05	4.4	●	●	●	●
DCGT11T301L-NM	11.6	9.525	3.97	0.1	4.4	●	●	●	●
DCGT11T302L-NM	11.6	9.525	3.97	0.2	4.4	●	●	●	●
DCGT0702005R-NF	7.8	6.35	2.38	0.05	2.8	●	●	●	●
DCGT070201R-NF	7.8	6.35	2.38	0.1	2.8	●	●	●	●
DCGT070202R-NF	7.8	6.35	2.38	0.2	2.8	●	●	●	●
DCGT11T3005R-NF	11.6	9.525	3.97	0.05	4.4	●	●	●	●
DCGT11T301R-NF	11.6	9.525	3.97	0.1	4.4	●	●	●	●
DCGT11T302R-NF	11.6	9.525	3.97	0.2	4.4	●	●	●	●
DCGT0702005L-NF	7.8	6.35	2.38	0.05	2.8	●	●	●	●
DCGT070201L-NF	7.8	6.35	2.38	0.1	2.8	●	●	●	●
DCGT070202L-NF	7.8	6.35	2.38	0.2	2.8	●	●	●	●
DCGT11T3005L-NF	11.6	9.525	3.97	0.05	4.4	●	●	●	●
DCGT11T301L-NF	11.6	9.525	3.97	0.1	4.4	●	●	●	●
DCGT11T302L-NF	11.6	9.525	3.97	0.2	4.4	●	●	●	●

Recommended cutting data see page 28-29



DC**

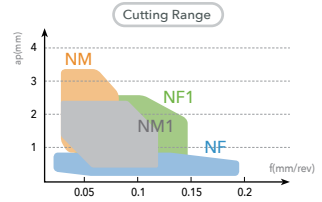
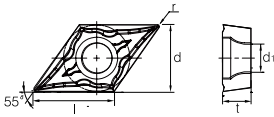

Unit: mm

Specification	Dimensions					Coated			Uncoated
	l	Ød	t	r	Ød1	NP5030	NP9030	NP1030	NU8000
DCGT11T301-NM1	11.6	9.525	3.97	0.09	4.4	●	●	●	●
DCGT11T302-NM1	11.6	9.525	3.97	0.19	4.4	●	●	●	●
DCGT11T304-NM1	11.6	9.525	3.97	0.39	4.4	●	●	●	●

Recommended cutting data see page 28-29

DC**

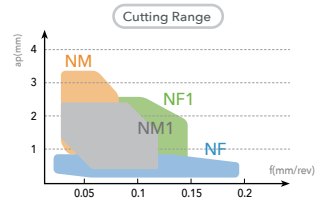
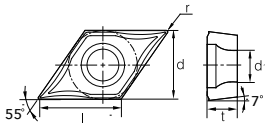

Unit: mm

Specification	Dimensions					Coated			Uncoated
	l	Ød	t	r	Ød1	NP5030	NP9030	NP1030	NU8000
DCGT070201-NF1	7.8	6.35	2.38	0.1	2.8	●	●	●	●
DCGT070202-NF1	7.8	6.35	2.38	0.2	2.8	●	●	●	●
DCGT070204-NF1	7.8	6.35	2.38	0.4	2.8	●	●	●	●
DCGT11T301-NF1	11.6	9.525	3.97	0.1	4.4	●	●	●	●
DCGT11T302-NF1	11.6	9.525	3.97	0.2	4.4	●	●	●	●
DCGT11T304-NF1	11.6	9.525	3.97	0.4	4.4	●	●	●	●

Recommended cutting data see page 28-29



STGC

External turning

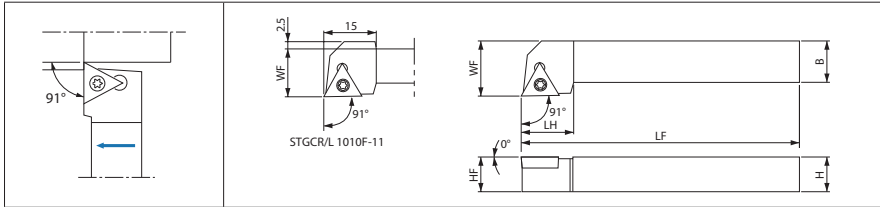

Right-hand shown

Unit: mm

Specification	Dimensions						Screw 	Wrench 	Insert	Std.R
	H	B	LH	HF	LF	WF				
STGCR/L0808E08	8	8	12	8	70	10	SB2050TR	T6	TC**0802...	0.2
STGCR/L1010F08	10	10	12	10	80	12	SB2050TR	T6	TC**0802...	0.2
STGCR/L1010F11	10	10	15	10	80	14	SB2070TR	T8	TC**1103...	0.4
STGCR/L1212H11	12	12	15	12	100	16	SB2070TR	T8	TC**1103...	0.4
STGCR/L1616H11	16	16	15	16	100	20	SB2070TR	T8	TC**1103...	0.4
STGCR/L2020K11	20	20	15	20	125	25	SB2070TR	T8	TC**1103...	0.4
STGCR/L2525M11	25	25	20	25	150	32	SB2070TR	T8	TC**1103...	0.4

Insert see page 18 



TC**

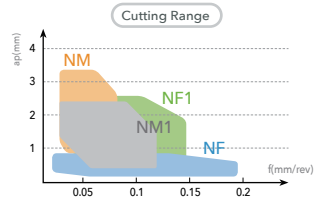
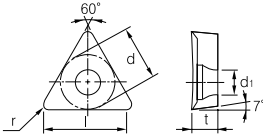

Specification	Dimensions					Coated			Uncoated
	l	Ød	t	r	Ød1	NP5030	NP9030	NP1030	NU8000
TCGT0802003R-NF	8.15	4.76	2.38	0.05	2.38	●	●	●	●
TCGT080201R-NF	8	4.76	2.38	0.1	2.38	●	●	●	●
TCGT080202R-NF	7.7	4.76	2.38	0.2	2.38	●	●	●	●
TCGT0802003L-NF	8.15	4.76	2.38	0.05	2.38	●	●	●	●
TCGT080201L-NF	8	4.76	2.38	0.1	2.38	●	●	●	●
TCGT080202L-NF	7.7	4.76	2.38	0.2	2.38	●	●	●	●
TCGT1103003R-NF	10.53	6.35	3.18	0.03	2.8	●	●	●	●
TCGT110301R-NF	10.53	6.35	3.18	0.1	2.8	●	●	●	●
TCGT110301L-NF	10.53	6.35	3.18	0.1	2.8	●	●	●	●
TCGT110302R-NF	10.53	6.35	3.18	0.2	2.8	●	●	●	●
TCGT110302L-NF	10.53	6.35	3.18	0.2	2.8	●	●	●	●
TCET1103003R-NF	10.53	6.35	3.18	0.03	2.8	●	●	●	●
TCET1103003L-NF	10.53	6.35	3.18	0.03	2.8	●	●	●	●
TCET110301R-NF	10.53	6.35	3.18	0.1	2.8	●	●	●	●
TCET110301L-NF	10.53	6.35	3.18	0.1	2.8	●	●	●	●
TCET110302R-NF	10.53	6.35	3.18	0.2	2.8	●	●	●	●
TCET110302L-NF	10.53	6.35	3.18	0.2	2.8	●	●	●	●

Recommended cutting data see page 28-29



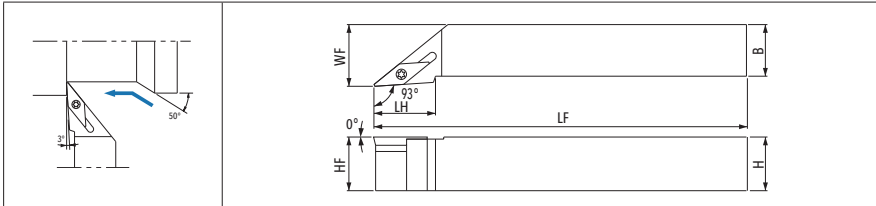

SVJB

External turning / External copying, Screw clamp



Right-hand shown

Unit: mm

Specification	Dimensions						Screw 	Wrench 	Insert	Std. R
	H	B	LH	HF	LF	WF				
SVJBR/L2020K11	20	20	30	120	10	0	SB2570TR	T8	VB**1103...	0.4
SVJBR/L2525M11	25	25	35	120	12	0	SB2570TR	T8	VB**1103...	0.4

Insert see page 23 



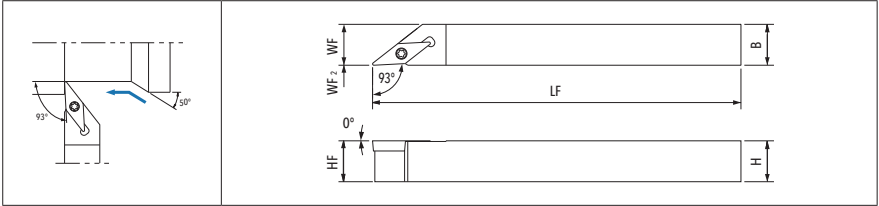

SVJB-FF

External turning / External copying, Screw clamp, Without offset



Right-hand shown

Unit: mm

Specification	Dimensions						Screw	Wrench	Insert	Std.R
	H	B	HF	LF	WF	WF2				
SVJBR/L1010JX11FF	10	10	10	120	10	0	SB2570TR	T8	VB**1103...	0.4
SVJBR/L1212JX11FF	12	12	12	120	12	0	SB2570TR	T8	VB**1103...	0.4
SVJBR/L1616JX11FF	16	16	16	120	16	0	SB2570TR	T8	VB**1103...	0.4
SVJBR/L2020JX11FF	20	20	20	120	20	0	SB2570TR	T8	VB**1103...	0.4

Insert see page 23 



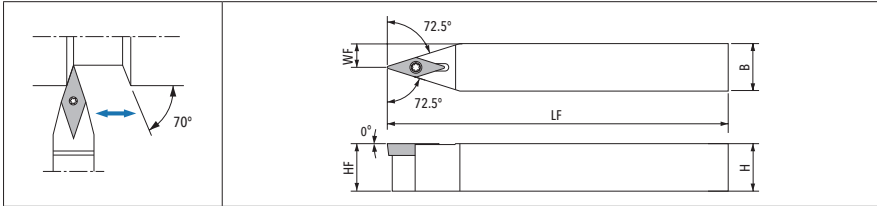

SVVB

External turning / External copying



Unit: mm

Specification	Dimensions					Screw	Wrench	Insert	Std. R
	H	B	HF	LF	WF				
SWBN1010F11	10	10	10	80	5	SB2570TR	T8	VB**1103...	0.4
SWBN1010JX11	10	10	10	120	5	SB2570TR	T8	VB**1103...	0.4
SWBN1212F11	12	12	12	85	6	SB2570TR	T8	VB**1103...	0.4
SWBN1212JX11	12	12	12	120	6	SB2570TR	T8	VB**1103...	0.4
SWBN1616H11	16	16	16	100	8	SB2570TR	T8	VB**1103...	0.4
SWBN1616JX11	16	16	16	120	8	SB2570TR	T8	VB**1103...	0.4
SWBN2020K11	20	20	20	125	10	SB2570TR	T8	VB**1103...	0.4
SWBN2525M11	25	25	25	150	12.5	SB2570TR	T8	VB**1103...	0.4

Insert see page 23 



S-SVUB

External turning / External copying

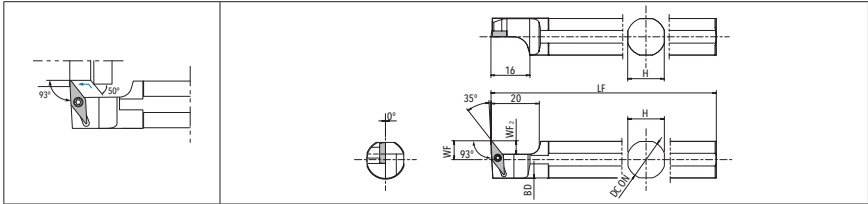

Left-hand shown | Right-hand Insert for Left-hand Toolholder.

Unit: mm

Specification	Dimensions						Screw	Wrench	Insert	Std.R
	DCON	HF	HBKW	LF	WF	WF2				
S19G-SVUBL11	19.05	17	18.4	90	10.5	8	SB2070TR	T8	VB**1103...	0.4
S19K-SVUBL11	19.05	17	18.4	120	10.5	8	SB2070TR	T8	VB**1103...	0.4
S20G-SVUBL11	20	18	19.4	90	10.5	8	SB2070TR	T8	VB**1103...	0.4
S20K-SVUBL11	20	18	19.4	120	10.5	8	SB2070TR	T8	VB**1103...	0.4
S25.0H-SVUBL11	25	23	24.4	100	10.5	8	SB2070TR	T8	VB**1103...	0.4
S25K-SVUBL11	25.4	23	24.8	120	10.5	8	SB2070TR	T8	VB**1103...	0.4

Insert see page 23



ISO Turning Inserts

VB**

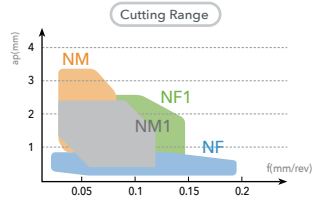
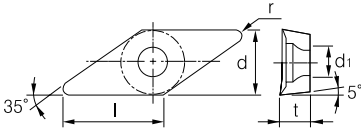

Unit: mm

Specification	Dimensions					Coated			Uncoated
	l	Ød	t	r	Ød1	NP5030	NP5030	NP1030	NU8000
VBGT1103003R-NF	7.8	6.35	2.38	0.05	2.8	●	●	●	●
VBGT110301R-NF	7.8	6.35	2.38	0.1	2.8	●	●	●	●
VBGT110302R-NF	7.8	6.35	2.38	0.2	2.8	●	●	●	●
VBGT1103003L-NF	11.6	9.525	3.97	0.05	4.4	●	●	●	●
VBGT110301L-NF	11.6	9.525	3.97	0.1	4.4	●	●	●	●
VBGT110302L-NF	11.6	9.525	3.97	0.2	4.4	●	●	●	●
VBGT113003R-NM	7.8	6.35	2.38	0.05	2.8	●	●	●	●
VBGT110301R-NM	7.8	6.35	2.38	0.1	2.8	●	●	●	●
VBGT110302R-NM	7.8	6.35	2.38	0.2	2.8	●	●	●	●
VBGT1103003L-NM	11.6	9.525	3.97	0.05	4.4	●	●	●	●
VBGT110301L-NM	11.6	9.525	3.97	0.1	4.4	●	●	●	●
VBGT110302L-NM	11.6	9.525	3.97	0.2	4.4	●	●	●	●

Recommended cutting data see page 28-29



SVJC-FF

External turning / External copying, Screw clamp, Without offset

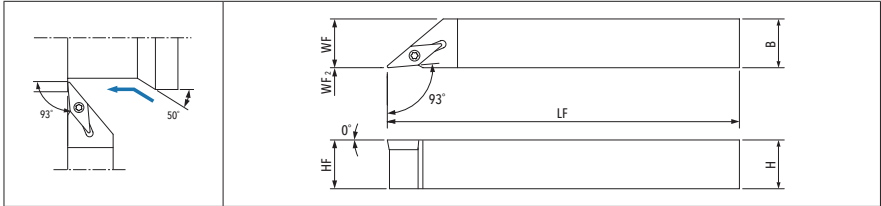

Right-hand shown

Unit: mm

Specification	Dimensions						Screw	Wrench	Insert	Std.R
	H	B	HF	LF	WF	WF2				
SVJCR/L1010JX11FF	10	10	10	120	10	0	SB2070TR	T8	VC**1103...	0.2
SVJCR/L1212F11FF	12	12	12	85	12	0	SB2070TR	T8	VC**1103...	0.2
SVJCR/L1212JX11FF	12	12	12	120	12	0	SB2070TR	T8	VC**1103...	0.2
SVJCR/L1616JX11FF	16	16	16	120	16	0	SB2070TR	T8	VC**1103...	0.2
SVJCR/L2020JX11FF	20	20	20	120	20	0	SB2070TR	T8	VC**1103...	0.2

Insert see page 26-27



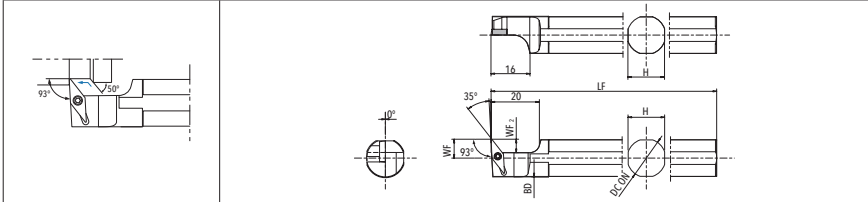

S-SVUC

External turning / External copying



Left-hand shown | Right-hand insert for Left-hand Toolholder.

Unit: mm

Specification	Dimensions						Screw 	Wrench 	Insert	Std.R
	DCON	HF	HBKW	LF	WF	WF2				
S12F-SVUCL08	12	11	13.4	80	7.5	5.5	SB2050TR	T6	VC**0802...	0.4
S14H-SVUCL08	14	13	13.4	100	7.5	5.5	SB2050TR	T6	VC**0802...	0.4
S15F-SVUCL08	15.875	15	15.4	85	8	5.5	SB2050TR	T6	VC**0802...	0.4
S16F-SVUCL08	16	15	15.4	85	8	5.5	SB2050TR	T6	VC**0802...	0.4
S19G-SVUCL11	19.05	17	18.4	90	10.5	8	SB2070TR	T8	VC**1103...	0.2
S19K-SVUCL11	19.05	17	18.4	120	10.5	8	SB2070TR	T8	VC**1103...	0.2
S20G-SVUCL11	20	18	19.4	90	10.5	8	SB2070TR	T8	VC**1103...	0.2
S20K-SVUCL11	20	18	19.4	120	10.5	8	SB2070TR	T8	VC**1103...	0.2
S25.0H-SVUCL11	25	23	24.4	100	10.5	8	SB2070TR	T8	VC**1103...	0.2
S25K-SVUCL11	25.4	23	24.8	120	10.5	8	SB2070TR	T8	VC**1103...	0.2

Insert see page 26-27





VC**

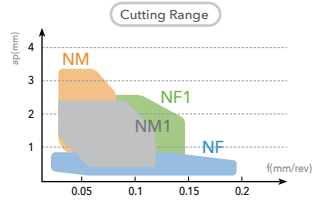
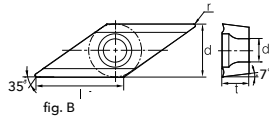
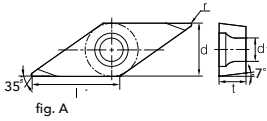

Specification	Fig.	Dimensions					Coated			Uncoated
		l	Ød	t	r	Ød1	NP030	NP030	NP1030	NU8000
VCGT1103003R-NF	A	11	6.35	3.18	0.03	2.8	●	●	●	●
VCGT110301R-NF	A	11	6.35	3.18	0.1	2.8	●	●	●	●
VCGT110302R-NF	A	11	6.35	3.18	0.2	2.8	●	●	●	●
VCGT1103003L-NF	A	11	6.35	3.18	0.03	2.8	●	●	●	●
VCGT110301L-NF	A	11	6.35	3.18	0.1	2.8	●	●	●	●
VCGT110302L-NF	A	11	6.35	3.18	0.2	2.8	●	●	●	●
VCGT1103003R-NM	B	11	6.35	3.18	0.03	2.8	●	●	●	●
VCGT110301R-NM	B	11	6.35	3.18	0.1	2.8	●	●	●	●
VCGT110302R-NM	B	11	6.35	3.18	0.2	2.8	●	●	●	●
VCGT1103003L-NM	B	11	6.35	3.18	0.03	2.8	●	●	●	●
VCGT110301L-NM	B	11	6.35	3.18	0.1	2.8	●	●	●	●
VCGT110302L-NM	B	11	6.35	3.18	0.2	2.8	●	●	●	●

Recommended cutting data see page 28-29



ISO Turning Inserts

VC**

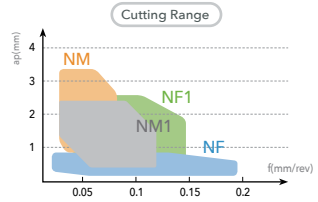
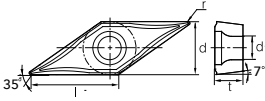

Unit: mm

Specification	Dimensions					Coated			Uncoated
	l	Ød	t	r	Ød1	NP5030	NP9030	NP1030	NU8000
VCGT110301-NF1	11	6.35	3.18	0.1	2.8	●	●	●	●
VCGT110302-NF1	11	6.35	3.18	0.2	2.8	●	●	●	●
VCGT110304-NF1	11	6.35	3.18	0.4	2.8	●	●	●	●
VCMT080202-NF1		4.76	2.38	0.2	2.3	●	●	●	●
VCMT080204-NF1		4.76	2.38	0.4	2.3	●	●	●	●

Recommended cutting data see page 28-29





External turning (positive insert)

ISO	Workpiece material	Hardness	Cutting range	Applications	Chipbreaker	Insert grade	Corner-R (RE)	Lower limit - Recommendation - Upper limit		
								Vc (m/min)	ap (mm)	f (mm/rev)
P	Low carbon steel Low carbon alloy	HB ≤ 300	Precision Finishing	Continuous	NF	NP5030	0.05	100 - 150 - 200	0.05 - 0.07 - 0.15	0.03 - 0.05 - 0.1
			Interruption		NP5030	0.2	80 - 120 - 160	0.05 - 0.1 - 0.2	0.03 - 0.1 - 0.15	
			Precision Finishing Molded chipbreaker	Continuous	NF1	NP5030	0.2	100 - 150 - 200	0.02 - 0.05 - 0.1	0.02 - 0.05 - 0.12
			Finishing	Continuous	NF1	NP5030	0.2	100 - 140 - 180	0.2 - 0.5 - 1.0	0.05 - 0.1 - 0.2
	Interruption		NP5030	0.4	80 - 120 - 160	0.2 - 0.5 - 1.0	0.05 - 0.1 - 0.2			
	Finishing-Medium	Continuous	NM1	NP5030	0.2	80 - 120 - 160	0.8 - 3.0 - 5.0	0.03 - 0.05 - 0.1		
	Interruption		NP5030	0.4	60 - 100 - 140	0.8 - 2.0 - 3.0	0.03 - 0.05 - 0.1			
	Medium carbon steel Medium carbon alloy	HB ≤ 330	Precision Finishing	Continuous	NF	NP5030	0.05	100 - 150 - 200	0.05 - 0.07 - 0.15	0.03 - 0.05 - 0.1
			Interruption		NP5030	0.2	80 - 120 - 160	0.05 - 0.1 - 0.2	0.03 - 0.1 - 0.15	
			Precision Finishing Molded chipbreaker	Continuous	NF1	NP5030	0.2	100 - 150 - 200	0.02 - 0.05 - 0.1	0.02 - 0.05 - 0.12
			Finishing	Continuous	NF1	NP5030	0.2	100 - 140 - 180	0.2 - 0.5 - 1.0	0.05 - 0.1 - 0.2
	Interruption		NP5030	0.4	80 - 120 - 160	0.2 - 0.5 - 1.0	0.05 - 0.1 - 0.2			
Finishing-Medium	Continuous	NM1	NP5030	0.2	80 - 120 - 160	0.8 - 3.0 - 5.0	0.03 - 0.05 - 0.1			
Interruption		NP5030	0.4	60 - 100 - 140	0.8 - 2.0 - 3.0	0.03 - 0.05 - 0.1				
High carbon alloy	HB ≤ 280	Precision Finishing	Continuous	NF	NP5030	0.05	100 - 150 - 200	0.05 - 0.07 - 0.15	0.03 - 0.05 - 0.1	
		Interruption		NP5030	0.2	80 - 120 - 160	0.05 - 0.1 - 0.2	0.03 - 0.1 - 0.15		
		Precision Finishing Molded chipbreaker	Continuous	NF1	NP5030	0.2	100 - 150 - 200	0.02 - 0.05 - 0.1	0.02 - 0.05 - 0.12	
		Finishing	Continuous	NF1	NP5030	0.2	100 - 140 - 180	0.2 - 0.5 - 1.0	0.05 - 0.1 - 0.2	
Interruption		NP5030	0.4	80 - 120 - 160	0.2 - 0.5 - 1.0	0.05 - 0.1 - 0.2				
Finishing-Medium	Continuous	NM1	NP5030	0.2	80 - 120 - 160	0.3 - 1.5 - 3.0	0.03 - 0.05 - 0.1			
Interruption		NP5030	0.4	60 - 100 - 140	0.3 - 1.0 - 2.0	0.03 - 0.05 - 0.1				
M	Stainless steel (Austenitic related)	HB ≤ 220	Finishing	Continuous	NF1	NP5030	0.2	80 - 100 - 120	0.1 - 0.3 - 0.5	0.03 - 0.05 - 0.1
			Interruption		NP9030	0.4	60 - 80 - 100	0.3 - 0.5 - 1.0	0.05 - 0.1 - 0.15	
	Medium	Continuous	NM1	NP5030	0.2	80 - 100 - 120	0.5 - 1.5 - 3.0	0.03 - 0.08 - 0.12		
	Interruption		NP9030	0.4	60 - 80 - 100	0.5 - 1.0 - 2.0	0.05 - 0.1 - 0.15			
Stainless steel (Precipitation Hardening)	HB ≤ 300	Finishing	Continuous	NF1	NP5030	0.2	40 - 60 - 80	0.1 - 0.3 - 0.5	0.03 - 0.05 - 0.1	
		Interruption		NP9030	0.4	30 - 50 - 70	0.3 - 0.5 - 1.0	0.05 - 0.1 - 0.15		
Medium	Continuous	NM1	NP5030	0.2	40 - 60 - 80	0.5 - 1.0 - 2.0	0.03 - 0.08 - 0.12			
Interruption		NP9030	0.4	30 - 50 - 70	0.5 - 1.0 - 1.5	0.05 - 0.1 - 0.15				



Recommended Cutting Data

External turning (positive insert) - cutting diameter under $\varnothing 16\text{mm}$

ISO	Workpiece material	Hardness	Cutting range	Applications	Chipbreaker	Insert grade	Corner-R (RE)	Lower limit - Recommendation - Upper limit		
								Vc (m/min)	ap (mm)	f (mm/rev)
K	Gray cast iron	HB \leq 250	Finishing	Continuous Interruption	Standard	NC6010	0.4	100 - 120 - 150	0.2 - 0.5 - 1.0	0.1 - 0.15 - 0.2
			Medium	Continuous Interruption	Standard	NC6010	0.4	80 - 100 - 120	0.2 - 0.5 - 1.0	0.05 - 0.1 - 0.15
	Nodular cast iron	HB \leq 270	Finishing	Continuous Interruption	Standard	NC6010	0.4	100 - 120 - 150	0.5 - 1.0 - 2.0	0.1 - 0.15 - 0.2
			Medium	Continuous Interruption	Standard	NC6010	0.8	80 - 100 - 120	0.5 - 1.0 - 2.0	0.05 - 0.1 - 0.15
N	Non-ferrous metals Copper alloy Aluminum Aluminum alloys (S10% or less) etc.	HB \leq 100	High speed machining (Rainbow surface gloss)	Continuous	-	PCD800	0.2	150 - 250 - 350	0.05 - 0.1 - 0.3	0.05 - 0.1 - 0.15
			Finishing (Long tool life)	Continuous Interruption	AL	MU8100	0.2	100 - 150 - 200	0.05 - 0.3 - 0.5	0.02 - 0.07 - 0.1
			Finishing	Continuous Interruption	AL	MU8100	0.4	100 - 150 - 200	0.05 - 0.3 - 0.5	0.02 - 0.07 - 0.1
			Medium	Continuous Interruption	AL	NP1030	0.2	100 - 150 - 200	0.05 - 0.3 - 0.5	0.02 - 0.07 - 0.1
M	Titanium alloys	HB \leq 400	Precision Finishing (Rainbow surface gloss)	Continuous Interruption	-	PCD800	0.2	100 - 120 - 150	0.05 - 0.1 - 0.3	0.03 - 0.07 - 0.1
			Medium	Continuous Interruption	F	NP1030	0.4	70 - 100 - 120	0.05 - 0.1 - 0.3	0.03 - 0.07 - 0.1
	Heat-resistant alloys	HB \leq 350	Finishing	Continuous Interruption	-	NP1030	0.4	30 - 50 - 70	0.1 - 0.5 - 1.0	0.03 - 0.1 - 0.2
			Finishing	Continuous Interruption	F	NP1030	0.8	30 - 50 - 70	0.1 - 0.5 - 1.0	0.03 - 0.1 - 0.2
H	Hardened steel Hard materials	HRC 40 - 50	Finishing	Continuous Interruption	F	NP5030	0.4	10 - 30 - 50	0.1 - 0.3 - 0.5	0.03 - 0.05 - 0.1
			Finishing	Continuous Interruption	F	NP9030	0.4	40 - 60 - 80	0.1 - 0.3 - 0.5	0.03 - 0.05 - 0.1
		HRC 50 - 68	Finishing	Continuous Interruption	T	NP5030	0.8	40 - 60 - 80	0.1 - 0.3 - 0.5	0.03 - 0.05 - 0.1
			Finishing	Continuous Interruption	T	NBT9540	0.2	40 - 60 - 80	0.1 - 0.3 - 0.5	0.02 - 0.07 - 0.1
							0.4	80 - 120 - 150	0.1 - 0.3 - 0.5	0.02 - 0.07 - 0.1
							0.4	60 - 100 - 120	0.1 - 0.3 - 0.5	0.02 - 0.07 - 0.1



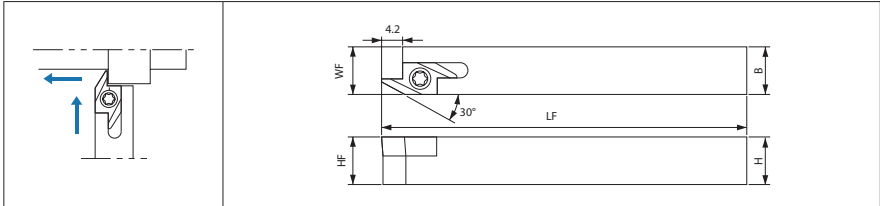

SABS-40F

Back turning / Edge width : 2.8mm, Max. depth : 4mm



Unit: mm

Specification	Dimensions					Screw 	Wrench 	Insert	Std.R
	H	B	HF	LF	WF				
SABSR1010JX40F	10	10	10	120	10.2	SB3080TR	T10	ABS15R40...	0.15
SABSR1212F40F	12	12	12	85	12.2	SB3080TR	T10	ABS15R40...	0.15
SABSR1212JX40F	12	12	12	120	12.2	SB3080TR	T10	ABS15R40...	0.15
SABSR1616JX40F	16	16	16	120	16.2	SB3080TR	T10	ABS15R40...	0.15
SABSR2020K40F	20	20	20	125	20.2	SB3080TR	T10	ABS15R40...	0.15

Insert see page 31 



Turning Indexable Inserts

ABS**

Back turning

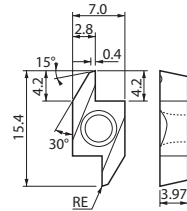

Unit: mm

Specification	Dimensions	Carbide				Cermat	
		PVD				NMS500	NMS100
		NPS030	NP9030	NP1030	NU8000		
ABS15R4005M	< 0.05	●	●	●			
ABS15R4015M	< 0.15	●	●	●			
ABS15R4005	0.05				●	●	●
ABS15R4015	0.15				●	●	●

Applicable Range

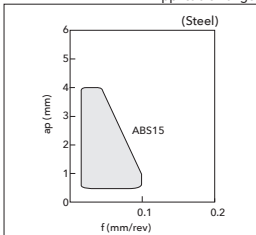

Recommended cutting data see page 35





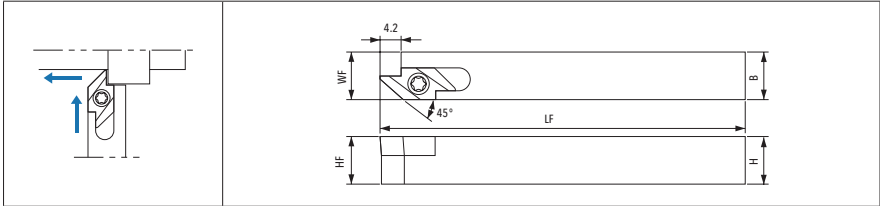

SABW-40F

Back turning / Edge width : 4.7mm, Max. depth : 4mm



Unit: mm

Specification	Dimensions					Screw 	Wrench 	Insert	Std.R
	H	B	HF	LF	WF				
SABWR1010JX40F	10	10	10	120	10.2	SB3080TR	T10	ABW15R40...	0.15
SABWR1212JX40F	12	12	12	120	12.2	SB3080TR	T10	ABW15R40...	0.15
SABWR1616JX40F	16	16	16	120	16.2	SB3080TR	T10	ABW15R40...	0.15
SABWR2020K40F	20	20	20	125	20.2	SB3080TR	T10	ABW15R40...	0.15

Insert see page 34 



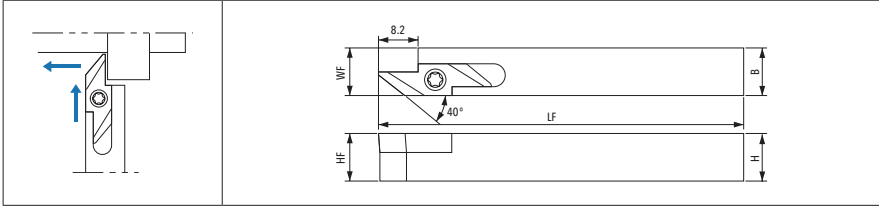

SABW-50F

Back turning / Edge width : 4.7mm, Max. depth : 5mm



Unit: mm

Specification	Dimensions					Screw	Wrench	Insert	Std. R
	H	B	HF	LF	WF				
SABWR1010JX50F	10	10	10	120	10.2	SB3080TR	T10	ABW23R50...	0.15
SABWR1212JX50F	12	12	12	120	12.2	SB3080TR	T10	ABW23R50...	0.15
SABWR1616JX50F	16	16	16	120	16.2	SB3080TR	T10	ABW23R50...	0.15
SABWR2020K50F	20	20	20	125	20.2	SB3080TR	T10	ABW23R50...	0.15

Insert see page 34





ABW**

Back turning

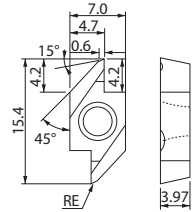

Unit: mm

Specification	Dimensions	Carbide					Cermet
		PVD					
		NP5030	NP9030	NP1030	NJ8000	NM5000	NM1500
ABW15R4005M	< 0.05	•	•	•			
ABW15R4015M	< 0.15	•	•	•			
ABW15R4005	0.05				•	•	•
ABW15R4015	0.15				•	•	•
ABW23R5005M	< 0.05	•		•			
ABW23R5015M	< 0.15	•	•	•			
ABW23R5005	0.05				•	•	•
ABW23R5015	0.15				•	•	•

Applicable Range

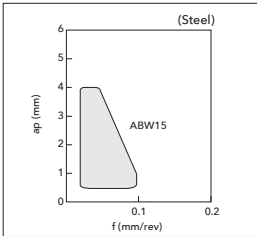

Recommended cutting data see page 35





Recommended Cutting Data

ABS15, ABW15

Workpiece material		NP5030		PVD coated carbide NP1030		Remarks
		Grooving	Turning	Grooving	Turning	
Carbon steel / Alloy steel	Vc (m/min)	★ 60 ~ 180		☆ 80 ~ 100		Coolant
	f (mm/rev)	0.02	0.02 ~ 0.07	0.02	0.02 ~ 0.07	
Stainless steel	Vc (m/min)	☆ 30 ~ 130		☆ 30 ~ 50		
	f (mm/rev)	0.02	0.02 ~ 0.05	0.02	0.02 ~ 0.05	

Workpiece material		Carbide NU8000		Remarks
		Grooving	Turning	
Aluminum	Vc (m/min)	150 ~ 200		Coolant
	f (mm/rev)	0.02	0.02 ~ 0.10	
Brass	Vc (m/min)	100 ~ 160		
	f (mm/rev)	0.03	0.02 ~ 0.15	

★: 1st recommendation

☆: 2nd recommendation



Code Key - TKF/TKFB

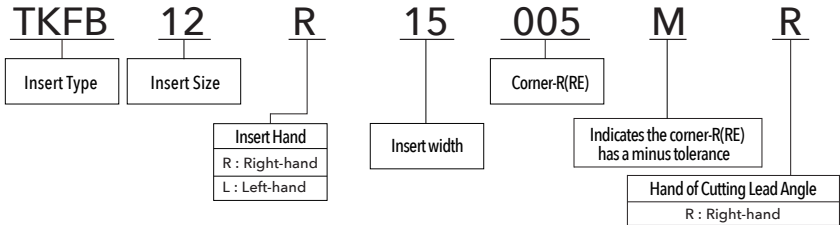
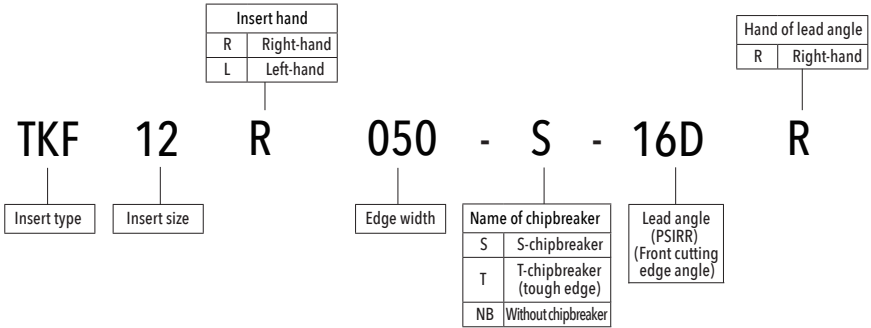
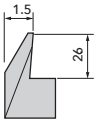
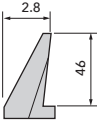
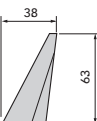
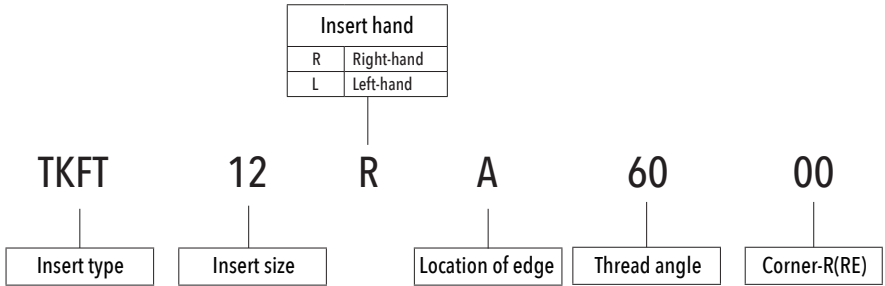

Table 1

Small machining	General purpose	Large machining
 <p>TKFB12R15..</p>	 <p>TKFB12R28</p>	 <p>TKFB16R38..</p>



Code Key - TKFT



For threading







TKFT



Applicable for various type of threading

Metric (M)	Parallel pipe [G(PF)]
Unified (UN)	Tapered pipe [R(PT) (BSPT)]

Table 1

Right-hand insert		
A type	B type	N type
 TKFT12RA..	 TKFT12RB..	 TKFT12RN..
Left-hand insert		
A type	B type	N type
 TKFT12LA..	 TKFT12LB..	 TKFT12LN..



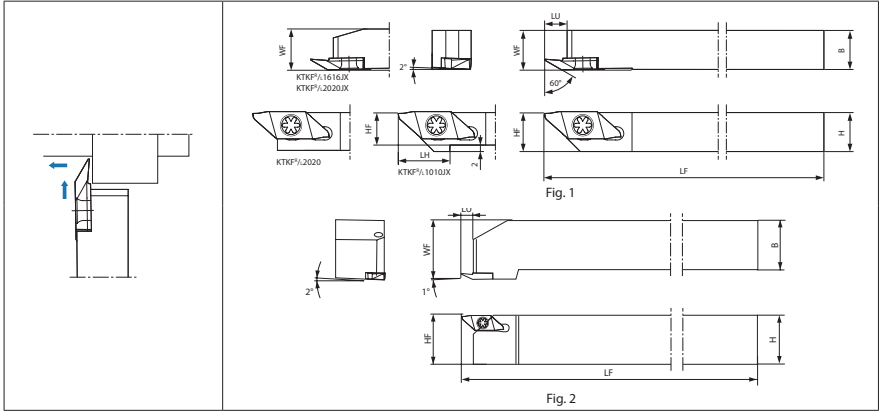

KTKF

Back turning



Right-hand shown | Right-hand Insert for Right-hand Toolholder, Left-hand Insert for Left-hand Toolholder.

Unit: mm

Specification	Fig.	Dimensions						Screw	Wrench	Insert	
		H	B	LH	HF	LF	LU	WF			
KTKFR/L1010JX12	1	10	10	15	10	120	6	10	SB-4590TRWN	T10	TKF(B)12R/L...
KTKFR/L1212F12	1	12	12	-	12	85	6	12	SB-4590TRWN	T10	TKF(B)12R/L...
KTKFR/L1212JX12	1	12	12	-	12	120	6	12	SB-4590TRWN	T10	TKF(B)12R/L...
KTKFR/L1616JX12	1	16	16	-	16	120	6	16	SB-4590TRWN	T10	TKF(B)12R/L...
KTKFR/L2020JX12	1	20	20	-	20	120	6	20	SB-4590TRWN	T10	TKF(B)12R/L...
KTKFR/L2525M12	2	25	25	-	25	150	6	30	SB-4590TRWN	T10	TKF(B)12R/L...
KTKFR/L1010JX16	1	10	10	20	10	120	8	10	SB-4590TRWN	T10	TKF(B)16R/L...
KTKFR/L1212F16	1	12	12	-	12	85	8	12	SB-4590TRWN	T10	TKF(B)16R/L...
KTKFR/L1212JX16	1	12	12	-	12	120	8	12	SB-4590TRWN	T10	TKF(B)16R/L...
KTKFR/L1616JX16	1	16	16	-	16	120	8	16	SB-4590TRWN	T10	TKF(B)16R/L...
KTKFR/L2020JX16	1	20	20	-	20	120	8	20	SB-4590TRWN	T10	TKF(B)16R/L...
KTKFR/L2525M16	2	25	25	-	25	150	8	30	SB-4590TRWN	T10	TKF(B)16R/L...

Insert see page 40 



Toolholders For Back Turning

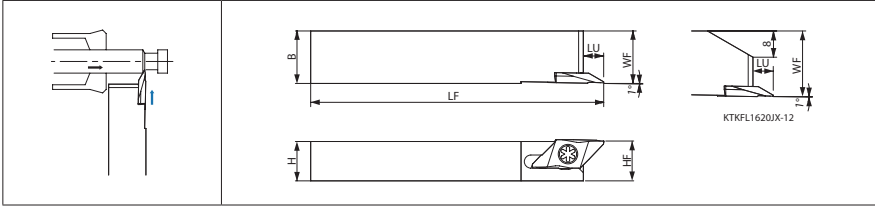

KTKF

Back turning



Left-hand shown | Left-hand Insert for Left-hand Toolholder.

Unit: mm

Specification	Dimensions						Screw	Wrench	Insert
	H	B	HF	LF	LU	WF			
KTKFL1216JX12	12	16	12	120	6	16	SB4590TRWN	T10	TKF(B)12L...
KTKFL1620JX12	16	20	16	120	6	20	SB4590TRWN	T10	TKF(B)12L...

Insert see page 40 

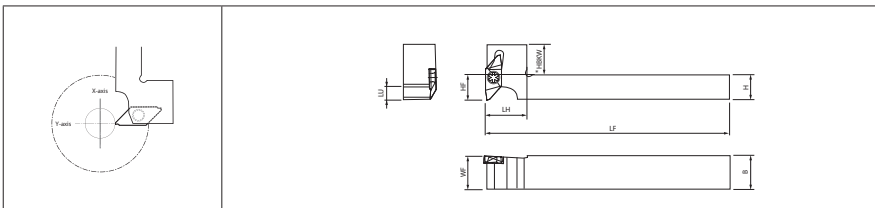

KTKF-Y

Back turning



Right-hand shown | Right-hand Insert for Right-hand Toolholder.

Unit: mm

Specification	Dimensions						Screw	Wrench	Insert	
	H	B	LH	HF	HBKW	LF	WF			
KTKFR1216JX12Y	12	16	20	12	15	120	16	SB4590TRWN	T10	TKF(B)12R...
KTKFR1620JX12Y	16	16	25	16	11	120	16	SB4590TRWN	T10	TKF(B)12R...

Insert see page 40 



TKFB

Back turning

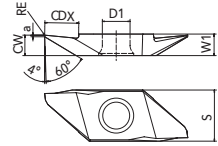

Unit: mm

Specification	Dimensions							Coated			Uncoated
	CW	CDX	S	D1	RE	W1	a	NPS030	NP9030	NPT030	NU8000
TKFB12R15005M	1.5	2.6	8.7	5.2	< 0.05	3	0.25	●	●	●	●
TKFB12R28005M	2.8	4.6	8.7	5.2	< 0.05	3	0.3	●	●	●	●
TKFB12R28010M	2.8	4.6	8.7	5.2	< 0.1	3	0.3	●	●	●	●
TKFB16R38005M	3.8	6.3	9.5	5.2	< 0.05	4	0.3	●	●	●	●
TKFB16R38010M	3.8	6.3	9.5	5.2	< 0.1	4	0.3	●	●	●	●
TKFB12L28005MR	2.8	4.6	8.7	5.2	< 0.05	3	0.3	●	●		
TKFB12L28010MR	2.8	4.6	8.7	5.2	< 0.1	3	0.3	●	●		
TKFB16L38005MR	3.8	6.3	9.5	5.2	< 0.05	4	0.3	●	●		
TKFB16L38010MR	3.8	6.6	9.5	5.2	< 0.1	4	0.3	●	●		

Recommended cutting data see page 50-51



Small Diameter Cut-off

KTKF

Cutting off

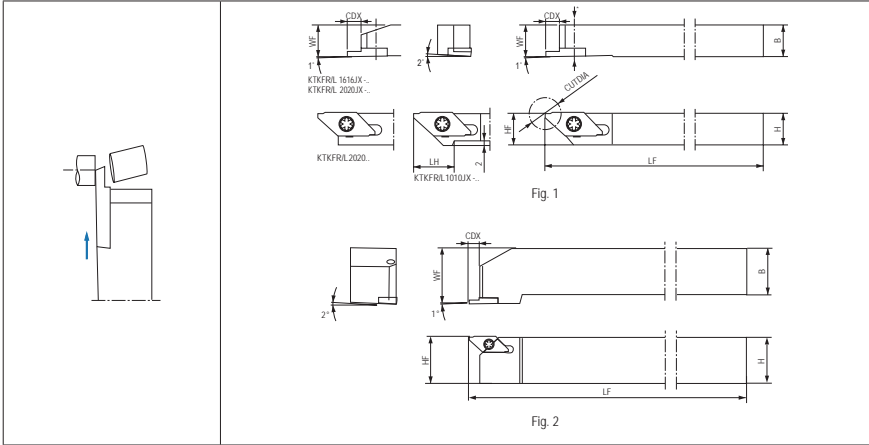

Right-hand shown | Right-hand Insert for Right-hand Toolholder, Left-hand Insert for Left-hand Toolholder.

Unit: mm

Specification	Fig.	Dimensions						Screw	Wrench	Insert
		H	B	LH	HF	LF	WF			
KTKFR/L1010JX12	1	10	10	15	10	120	10	SB4590TRWN	T10	TKF(B)12R/L...
KTKFR/L1212F12	1	12	12	-	12	85	12	SB4590TRWN	T10	TKF(B)12R/L...
KTKFR/L1212JX12	1	12	12	-	12	120	12	SB4590TRWN	T10	TKF(B)12R/L...
KTKFR/L1616JX12	1	16	16	-	16	120	16	SB4590TRWN	T10	TKF(B)12R/L...
KTKFR/L2020JX12	1	20	20	-	20	120	20	SB4590TRWN	T10	TKF(B)12R/L...
KTKFR/L2525M12	2	25	25	-	25	150	30	SB4590TRWN	T10	TKF(B)12R/L...
KTKFR/L1010JX16	1	10	10	20	10	120	10	SB4590TRWN	T10	TKF(B)16R/L...
KTKFR/L1212F16	1	12	12	-	12	85	12	SB4590TRWN	T10	TKF(B)16R/L...
KTKFR/L1212JX16	1	12	12	-	12	120	12	SB4590TRWN	T10	TKF(B)16R/L...
KTKFR/L1616JX16	1	16	16	-	16	120	16	SB4590TRWN	T10	TKF(B)16R/L...
KTKFR/L2020JX16	1	20	20	-	20	120	20	SB4590TRWN	T10	TKF(B)16R/L...
KTKFR/L2525M16	2	25	25	-	25	150	30	SB4590TRWN	T10	TKF(B)16R/L...

Insert see page 44-45 



KTKF-S

Cut-off / for sub spindle tooling

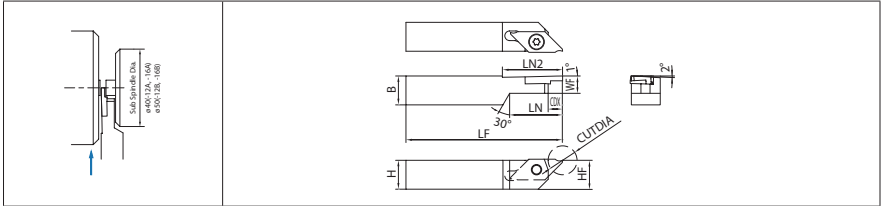

Right-hand shown | Right-hand Insert for Right-hand Toolholder.

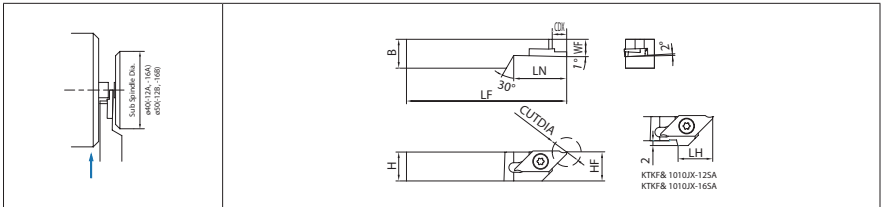

Left-hand shown | Left-hand Insert for Left-hand Toolholder.

Unit: mm

Specification	Dimensions									Screw	Wrench	Insert
	CDX	H	B	LH	HF	LF	LN	LN2	WF			
KTKFR/L1010JX-12SA	6	10	10	15	10	120	22	26	7.2	SB4570TRWN	T10	TKF(B)12R/L...
KTKFR/L1212F-12SA	6	12	12	-	12	85	22	26	7.2	SB4570TRWN	T10	TKF(B)12R/L...
KTKFR/L1212JX-12SB	6	12	12	-	12	120	26	26	7.2	SB4570TRWN	T10	TKF(B)12R/L...
KTKFR/L1010JX-16SA	8	10	10	20	10	120	22	30	7.2	SB4570TRWN	T10	TKF(B)12R/L...
KTKFR/L1212F-16SA	8	12	12	-	12	85	22	30	7.2	SB4570TRWN	T10	TKF(B)12R/L...
KTKFR/L1212JX-16SB	8	12	12	-	12	120	26	30	7.2	SB4570TRWN	T10	TKF(B)12R/L...

Insert see page 44-45



Small Diameter Cut-off

KTKF

Goose-neck holder

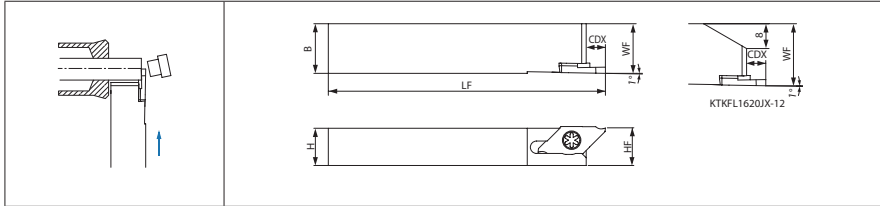

Left-hand shown | Left-hand Insert for Left-hand Toolholder.

Unit: mm

Specification	Dimensions						Screw	Wrench	Insert
	CDX	H	B	HF	LF	WF			
KTKFL1216JX12	6	12	16	12	120	16	SB-4590TRWN	T10	TKF12L...
KTKFL1620JX12	6	16	20	16	120	20	SB-4590TRWN	T10	TKF12L...

Insert see page 44-45

KTKF

Y-axis toolholder

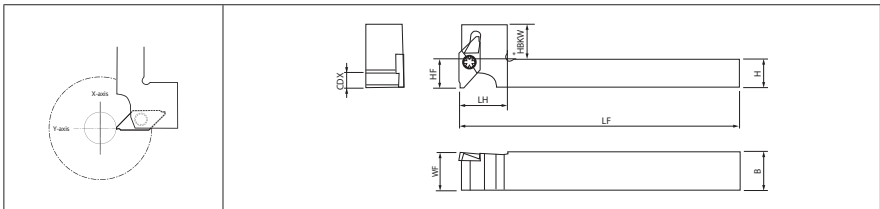

Right-hand shown | Right-hand Insert for Right-hand Toolholder.

Unit: mm

Specification	Dimensions								Screw	Wrench	Insert
	CDX	H	B	LH	HF	HBKW	LF	WF			
KTKFR1216JX12Y	6	12	16	20	12	15	120	16	SB4590TRWN	T10	TKF12R...
KTKFR1616JX12Y	6	16	16	25	16	11	120	16	SB4590TRWN	T10	TKF12R...

CDX shows the distance from the toolholder to the cutting edge.

Insert see page 44-45



TKF12

Small diameter cut-off

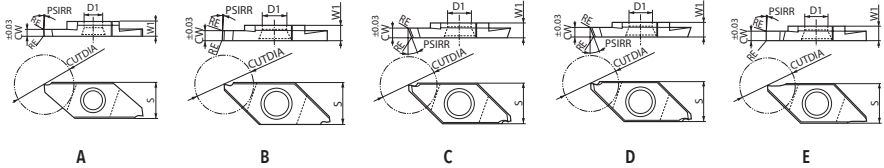

Unit: mm

Specification	Fig.	Dimensions						Angle (°)	Tolerance (mm)	Carbide			
		CW	S	D1	RE	W1	CUTDIA			PSIRR	CWmin.-max	NP5030	NP9030
TKF12R050-S	A	0.5	8.7	5	0.03	3	5	0	-0.03~+0.03	●	●	●	●
TKF12R070-S	A	0.7	8.7	5	0.03	3	8	0	-0.03~+0.03	●	●	●	●
TKF12100-S	A	1	8.7	5	0.03	3	12	0	-0.03~+0.03	●	●	●	●
TKF12125-S	A	1.25	8.7	5	0.03	3	12	0	-0.03~+0.03	●	●	●	●
TKF12150-S	A	1.5	8.7	5	0.03	3	12	0	-0.03~+0.03	●	●	●	●
TKF12200-S	A	2	8.7	5	0.03	3	12	0	-0.03~+0.03	●	●	●	●
TKF12L050-S	A	0.5	8.7	5	0.03	3	5	0	-0.03~+0.03	●	●	●	●
TKF12L070-S	A	0.7	8.7	5	0.03	3	8	0	-0.03~+0.03	●	●	●	●
TKF12L100-S	A	1	8.7	5	0.03	3	12	0	-0.03~+0.03	●	●	●	●
TKF12L125-S	A	1.25	8.7	5	0.03	3	12	0	-0.03~+0.03	●	●	●	●
TKF12L150-S	A	1.5	8.7	5	0.03	3	12	0	-0.03~+0.03	●	●	●	●
TKF12L200-S	A	2	8.7	5	0.03	3	12	0	-0.03~+0.03	●	●	●	●
TKF12R100-T	B	1	8.7	5	0.08	3	12	0	-0.03~+0.03	●	●	●	●
TKF12R150-T	B	1.5	8.7	5	0.08	3	12	0	-0.03~+0.03	●	●	●	●
TKF12R200-T	B	2	8.7	5	0.08	3	12	0	-0.03~+0.03	●	●	●	●
TKF12L100-T	B	1	8.7	5	0.08	3	12	0	-0.03~+0.03	●	●	●	●
TKF12L150-T	B	1.5	8.7	5	0.08	3	12	0	-0.03~+0.03	●	●	●	●
TKF12L200-T	B	2	8.7	5	0.08	3	12	0	-0.03~+0.03	●	●	●	●
TKF12R050-S-16DR	C	0.5	8.7	5	0.03	3	12	16	-0.03~+0.03	●	●	●	●
TKF12R070-S-16DR	C	0.7	8.7	5	0.03	3	12	16	-0.03~+0.03	●	●	●	●
TKF12R100-S-16DR	C	1	8.7	5	0.03	3	12	16	-0.03~+0.03	●	●	●	●
TKF12R125-S-16DR	C	1.25	8.7	5	0.03	3	12	16	-0.03~+0.03	●	●	●	●
TKF12R150-S-16DR	C	1.5	8.7	5	0.03	3	12	16	-0.03~+0.03	●	●	●	●
TKF12R200-S-16DR	C	2	8.7	5	0.03	3	12	16	-0.03~+0.03	●	●	●	●

Recommended cutting data see page 50-51



TKF12

Small diameter cut-off

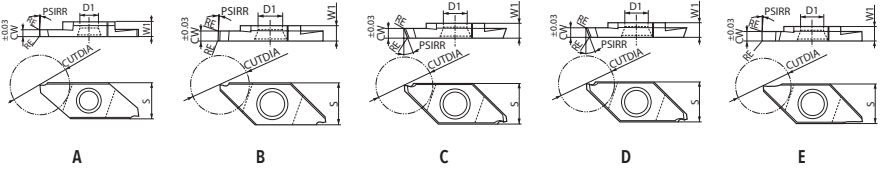

Unit: mm

Specification	Fig.	Dimensions						Angle (°)	Tolerance	Carbide			
		CW	S	D1	RE	W1	CUTDIA			PSIRR	CWmin.-max	NP5030	NP9030
TKF12L050-S-16DR	C	0.5	8.7	5	0.03	3	5	16	-0.03~+0.03	●	●	●	●
TKF12L070-S-16DR	C	0.7	8.7	5	0.03	3	8	16	-0.03~+0.03	●	●	●	●
TKF12L100-S-16DR	C	1	8.7	5	0.03	3	12	16	-0.03~+0.03	●	●	●	●
TKF12L125-S-16DR	C	1.25	8.7	5	0.03	3	12	16	-0.03~+0.03	●	●	●	●
TKF12L150-S-16DR	C	1.5	8.7	5	0.03	3	12	16	-0.03~+0.03	●	●	●	●
TKF12L200-S-16DR	C	2	8.7	5	0.03	3	12	16	-0.03~+0.03	●	●	●	●
TKF12R100-T-16DR	D	1	8.7	5	0.08	3	12	16	-0.03~+0.03	●	●	●	●
TKF12R150-T-16DR	D	1.5	8.7	5	0.08	3	12	16	-0.03~+0.03	●	●	●	●
TKF12R200-T-16DR	D	2	8.7	5	0.08	3	12	16	-0.03~+0.03	●	●	●	●
TKF12L100-T-16DR	D	1	8.7	5	0.08	3	12	16	-0.03~+0.03	●	●	●	●
TKF12L150-T-16DR	D	1.5	8.7	5	0.08	3	12	16	-0.03~+0.03	●	●	●	●
TKF12L200-T-16DR	D	2	8.7	5	0.08	3	12	16	-0.03~+0.03	●	●	●	●
TKF12R050-NB	E	0.5	8.7	5	0	3	5	0	-0.03~+0.03	●	●	●	●
TKF12R070-NB	E	0.7	8.7	5	0	3	8	0	-0.03~+0.03	●	●	●	●
TKF12R100-NB	E	1	8.7	5	0	3	12	0	-0.03~+0.03	●	●	●	●
TKF12R150-NB	E	1.5	8.7	5	0	3	12	0	-0.03~+0.03	●	●	●	●
TKF12R200-NB	E	2	8.7	5	0	3	12	0	-0.03~+0.03	●	●	●	●
TKF12L050-NB	E	0.5	8.7	5	0	3	5	0	-0.03~+0.03	●	●	●	●
TKF12L070-NB	E	0.7	8.7	5	0	3	8	0	-0.03~+0.03	●	●	●	●
TKF12L100-NB	E	1	8.7	5	0	3	12	0	-0.03~+0.03	●	●	●	●
TKF12L150-NB	E	1.5	8.7	5	0	3	12	0	-0.03~+0.03	●	●	●	●
TKF12L200-NB	E	2	8.7	5	0	3	12	0	-0.03~+0.03	●	●	●	●

Recommended cutting data see page 50-51





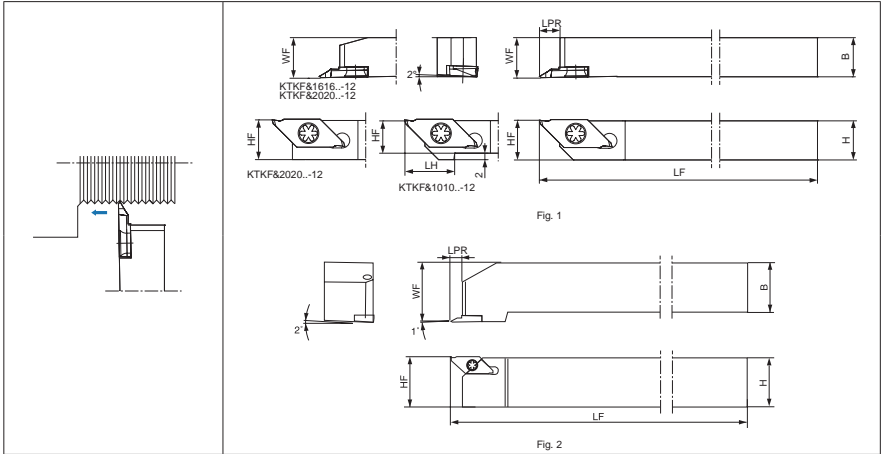

KTKF

External threading



Right-hand shown | Right-hand Insert for Right-hand Toolholder, Left-hand Insert for Left-hand Toolholder.

Unit: mm

Specification	Fig.	Dimensions							Screw 	Wrench 	Insert
		H	B	LH	LPR	HF	LF	WF			
KTKFR/L1010JX12	1	10	10	15	6	10	120	10	4590TRWN	T10	TKFT12R/L...
KTKFR/L1212F12	1	12	12	-	6	12	85	12	4590TRWN	T10	TKFT12R/L...
KTKFR/L1212JX12	1	12	12	-	6	12	120	12	4590TRWN	T10	TKFT12R/L...
KTKFR/L1616JX12	1	16	16	-	6	16	120	16	4590TRWN	T10	TKFT12R/L...
KTKFR/L2020JX12	1	20	20	-	6	20	120	20	4590TRWN	T10	TKFT12R/L...
KTKFR/L2525M12	2	25	25	-	6	25	150	30	4590TRWN	T10	TKFT12R...

Insert see page 48-49 



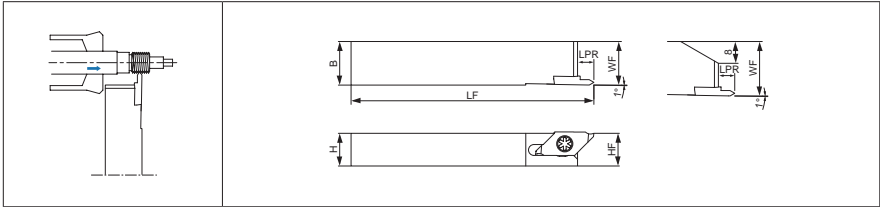

KTKF

External threading, Goose-neck holder



Left-hand shown | Left-hand Insert for Left-hand Toolholder.

Unit: mm

Specification	Dimensions						Screw 	Wrench 	Insert
	H	B	LPR	HF	LF	WF			
KTKFL1216JX12	12	16	6	12	120	16	SB-4590TRWN	T10	TKFT12L...
KTKFL1620JX12	16	20	6	16	120	20	SB-4590TRWN	T10	TKFT12L...

Insert see page 48-49 

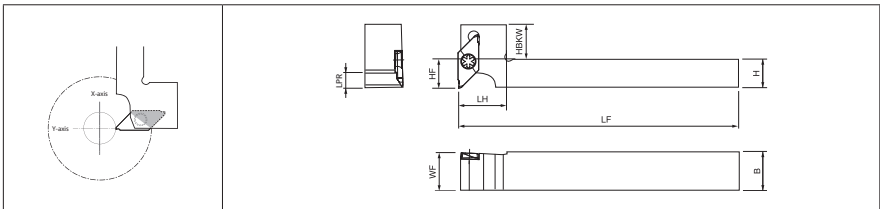

KTKF

External threading, Y-axis toolholder



Right-hand shown | Right-hand Insert for Right-hand Toolholder.

Unit: mm

Specification	Dimensions							Screw 	Wrench 	Insert	
	H	B	LH	HF	LPR	HBKW	LF				WF
KTKFR1216JX12Y	12	16	20	12	6	15	120	16	SB-4590TRWN	T10	TKFT12R...
KTKFR1616JX12Y	16	16	25	16	6	11	120	16	SB-4590TRWN	T10	TKFT12R...

LPR shows the distance from the toolholder to the cutting edge.

Insert see page 48-49 



TKFT

External threading

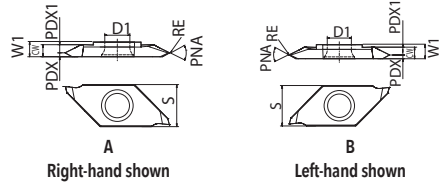

Unit: mm

Specification	Fig.	Dimensions							Carbide			
		CW	S	D1	RE	W1	PDX	PDX1	NP5030	NP9030	NP1030	NU8000
TKFT12RA6000	A	2.5	8.7	5.2	Max. 0.05	3	0.4	2.1	●	●	●	●
TKFT12RB6000	A	2.5	8.7	5.2	Max. 0.05	3	2.1	0.4	●	●	●	●
TKFT12RA60005	A	2.5	8.7	5.2	0.05	3	0.8	1.7	●	●	●	●
TKFT12RB60005	A	2.5	8.7	5.2	0.05	3	1.7	0.8	●	●	●	●
TKFT12RN6001	A	2.5	8.7	5.2	0.1	3	1.25	1.25	●	●	●	●
TKFT12RA55005	A	2.5	8.7	5.2	0.05	3	0.8	1.7	●	●	●	●
TKFT12RB55005	A	2.5	8.7	5.2	0.05	3	1.7	0.8	●	●	●	●
TKFT12LA6000	B	2.5	8.7	5.2	Max. 0.05	3	2.1	0.4	●	●	●	●
TKFT12LB6000	B	2.5	8.7	5.2	Max. 0.05	3	0.4	2.1	●	●	●	●
TKFT12LA60005	B	2.5	8.7	5.2	0.05	3	1.7	0.8	●	●	●	●
TKFT12LB60005	B	2.5	8.7	5.2	0.05	3	0.8	1.7	●	●	●	●
TKFT12LN6001	B	2.5	8.7	5.2	0.1	3	1.25	1.25	●	●	●	●
TKFT12LA55005	B	2.5	8.7	5.2	0.05	3	1.7	0.8	●	●	●	●
TKFT12LB55005	B	2.5	8.7	5.2	0.05	3	0.8	1.7	●	●	●	●

Recommended cutting data see page 50-51



TKFT

External threading

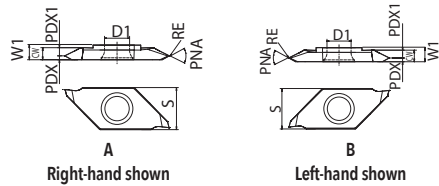

Unit: mm

Specification	Fig.	Thread type	Symbol thread type	Pitch		Profile type	Thread angle PNA (°)
				M(mm) min.-max	UN, G, R, W (TPI) min.-max		
TKFT12RA6000	A	Metric Unified	M/UN	0.2~0.6	64~48	Partial profile	60
TKFT12RB6000	A	Metric Unified	M/UN	0.2~0.6	64~48	Partial profile	60
TKFT12RA60005	A	Metric Unified	M/UN	0.5~1.25	48~24	Partial profile	60
TKFT12RB60005	A	Metric Unified	M/UN	0.5~1.25	48~24	Partial profile	60
TKFT12RN6001	A	Metric Unified	M/UN	1~1.5	24~18	Partial profile	60
TKFT12RA55005	A	Parallel/Tapered pipe Whitworth	G, R, W	-	40~16	Partial profile	55
TKFT12RB55005	A	Parallel/Tapered pipe Whitworth	G, R, W	-	40~16	Partial profile	55
TKFT12LA6000	B	Metric Unified	M/UN	0.2~0.6	64~48	Partial profile	60
TKFT12LB6000	B	Metric Unified	M/UN	0.2~0.6	64~48	Partial profile	60
TKFT12LA60005	B	Metric Unified	M/UN	0.5~1.25	48~24	Partial profile	60
TKFT12LB60005	B	Metric Unified	M/UN	0.5~1.25	48~24	Partial profile	60
TKFT12LN6001	B	Metric Unified	M/UN	1~1.5	24~18	Partial profile	60
TKFT12LA55005	B	Parallel/Tapered pipe Whitworth	G, R, W	-	40~16	Partial profile	55
TKFT12LB55005	B	Parallel/Tapered pipe Whitworth	G, R, W	-	40~16	Partial profile	55

Recommended cutting data see page 50-51





Recommended cutting conditions (TKF12 / 16)

Workpiece material	Recommended insert grades (Vc: m/min)					TKF12						TKF16		Remarks
	MEGACOAT NANO PLUS	MEGACOAT NANO	MEGACOAT	DLC coated carbide	Carbide	0.5	0.7	1.0	1.25	1.5	2.0	1.5	2.0	
	NP5030	NP9030	NP9030	MU8100	NP1030	Edge width CW (mm)								
f (mm/rev)														
Carbon steel	★ 70 ~ 170 (50 ~ 140)	☆ 70 ~ 150 (50 ~ 120)	☆ 70 ~ 150 (50 ~ 120)	-	-	0.01 ~ 0.02	0.01 ~ 0.03	0.01 ~ 0.04 (0.01 ~ 0.05)	0.01 ~ 0.04	0.01 ~ 0.04 (0.02 ~ 0.1)	0.01 ~ 0.04 (0.02 ~ 0.1)	0.02 ~ 0.07 (0.02 ~ 0.1)	0.02 ~ 0.07 (0.02 ~ 0.1)	Coolant
Alloy steel	★ 70 ~ 170 (50 ~ 140)	☆ 70 ~ 150 (50 ~ 120)	☆ 70 ~ 150 (50 ~ 120)	-	-	0.01 ~ 0.02	0.01 ~ 0.03	0.01 ~ 0.04 (0.01 ~ 0.05)	0.01 ~ 0.04	0.01 ~ 0.04 (0.02 ~ 0.1)	0.01 ~ 0.04 (0.02 ~ 0.1)	0.02 ~ 0.07 (0.02 ~ 0.1)	0.02 ~ 0.07 (0.02 ~ 0.1)	
Stainless steel	☆ 60 ~ 140 (40 ~ 120)	★ 60 ~ 120 (40 ~ 100)	☆ 60 ~ 120 (40 ~ 100)	-	-	0.005 ~ 0.015	0.01 ~ 0.02	0.01 ~ 0.02 (0.01 ~ 0.03)	0.01 ~ 0.02	0.01 ~ 0.02 (0.01 ~ 0.05)	0.01 ~ 0.02 (0.01 ~ 0.05)	0.01 ~ 0.04 (0.01 ~ 0.05)	0.01 ~ 0.04 (0.01 ~ 0.05)	
Cast iron	-	-	-	-	★ 50 ~ 100	0.01 ~ 0.03	0.01 ~ 0.04	0.01 ~ 0.05	0.01 ~ 0.05	0.01 ~ 0.05	0.01 ~ 0.05	0.02 ~ 0.08	0.02 ~ 0.08	
Aluminum alloys	-	-	-	★ 200 ~ 500	☆ 200 ~ 450	0.01 ~ 0.03	0.01 ~ 0.04	0.01 ~ 0.05	0.01 ~ 0.05	0.01 ~ 0.05	0.01 ~ 0.05	0.02 ~ 0.08	0.02 ~ 0.08	
Brass	-	-	-	-	★ 100 ~ 200	0.01 ~ 0.03	0.01 ~ 0.04	0.01 ~ 0.06	0.01 ~ 0.06	0.01 ~ 0.06	0.01 ~ 0.06	0.02 ~ 0.1	0.02 ~ 0.1	

*(): Tough edge type (TKF..T.)

★: 1st Recommendation ☆: 2nd Recommendation

Recommended cutting conditions

Workpiece material	Recommended insert grades			
	MEGACOAT NANO PLUS	MEGACOAT NANO	MEGACOAT	Carbide
	NP5030	NP9030	NP9030	NP1030
Carbon steel	Vc = 70 ~ 170 m/mim			
	First ap (Radial): 0.2mm and under			
Alloy steel	Vc = 70 ~ 170 m/mim			
	First ap (Radial): 0.2 mm and under			
Stainless steel	Vc = 60 ~ 100 m/mim			
	First ap (Radial): 0.15 mm and under			
Cast iron	-			
	Vc = 100 m/mim First ap (Radial): 0.2 mm and under			
Aluminum alloys	-			
	Vc = 150 ~ 400 m/mim First ap (Radial): 0.2 mm and under			
Brass	-			
	Vc = 150 ~ 300 m/mim First ap (Radial): 0.15 mm and under			

- Coolant is recommended.

- In case of threading stainless steel, please set two to three passes more than <ap - passes> listed below.



Recommended Cutting Data

Depth of cut & number of passes

TKFT 60° / 55° Partial profile

(ap shows the value of radial ap)

Type	Pitch (mm/TPI)	Description	Corner-R (RE)	Total ap (mm)	No. of passes	1	2	3	4	5	6	7	8	9	10	11						
Metric	External thread	TKFT 12R/LA/B6000	Max 0.05 Flat	0.20 mm	4	0.06	0.04	0.03	0.02													
				0.25 mm	4	0.07	0.06	0.04	0.02													
				0.30 mm	4	0.08	0.07	0.06	0.02													
				0.35 mm	5	0.08	0.07	0.06	0.04	0.02												
				0.40 mm	5	0.10	0.08	0.06	0.04	0.02												
				0.45 mm	5	0.10	0.08	0.06	0.04	0.04	0.02											
		TKFT 12R/LA/B6000	0.50 mm	12R/LA/B60005	0.05	0.38	6	0.10	0.10	0.07	0.05	0.04	0.02									
						0.33	5	0.10	0.10	0.07	0.04	0.02										
		TKFT 12R/LA/B6000	0.60 mm	12R/LA/B60005	Max 0.05 Flat	0.45	7	0.10	0.10	0.08	0.06	0.05	0.04	0.02								
						0.40	6	0.10	0.10	0.08	0.06	0.04	0.02									
						0.48	6	0.10	0.10	0.10	0.06	0.02										
						0.52	7	0.10	0.10	0.10	0.08	0.07	0.05	0.02								
						0.56	7	0.10	0.10	0.10	0.10	0.08	0.06	0.02								
						0.71	8	0.15	0.15	0.12	0.10	0.08	0.06	0.03	0.02							
						0.66	7	0.18	0.15	0.12	0.10	0.06	0.03	0.02								
						0.90	9	0.20	0.18	0.13	0.10	0.10	0.07	0.05	0.05	0.02						
TKFT 12R/LA/B60005	1.00 mm	12R/L N6001	0.10	0.85	8	0.20	0.18	0.13	0.10	0.10	0.07	0.05	0.02									
				1.04	10	0.20	0.18	0.14	0.12	0.10	0.10	0.08	0.05	0.05	0.02							
TKFT 12R/L N6001	1.50 mm		0.10	1.04	10	0.20	0.18	0.14	0.12	0.10	0.10	0.08	0.05	0.05	0.02							
				1.04	10	0.20	0.18	0.14	0.12	0.10	0.10	0.08	0.05	0.05	0.02							
Parallel pipe	External thread	TKFT 12R/LA/B55005	0.05	0.67	7	0.18	0.15	0.12	0.10	0.06	0.04	0.02										
				1.01	9	0.20	0.18	0.14	0.12	0.12	0.10	0.08	0.05	0.02								
				0.79	8	0.18	0.18	0.12	0.10	0.08	0.07	0.04	0.02									
Whitworth	External thread	TKFT 12R/LA/B55005	0.05	0.96	9	0.20	0.20	0.15	0.10	0.10	0.08	0.06	0.05	0.02								
				1.07	10	0.20	0.18	0.15	0.12	0.10	0.10	0.08	0.07	0.05	0.02							
				1.21	11	0.20	0.18	0.15	0.15	0.12	0.10	0.10	0.08	0.07	0.04	0.02						
				1.21	11	0.20	0.18	0.15	0.15	0.12	0.10	0.10	0.08	0.07	0.04	0.02						

Back Turning - cutting diameter under $\phi 16$ mm

KTKF

Workpiece material		MEGACOAT NANO PLUS		MEGACOAT NANO		Remarks
		NP5030		NP9030		
		Grooving	Turning	Grooving	Turning	
Carbon steel / Alloy steel	Vc (m/min)	★ 60 ~ 200		☆ 60 ~ 150		Coolant
	f (mm/rev)	0.01 ~ 0.03	0.02 ~ 0.15	0.01 ~ 0.03	0.02 ~ 0.15	
Stainless steel	Vc (m/min)	☆ 60 ~ 150		★ 60 ~ 130		
	f (mm/rev)	0.01 ~ 0.02	0.02 ~ 0.1	0.01 ~ 0.02	0.02 ~ 0.1	



Code system

Chip breaker

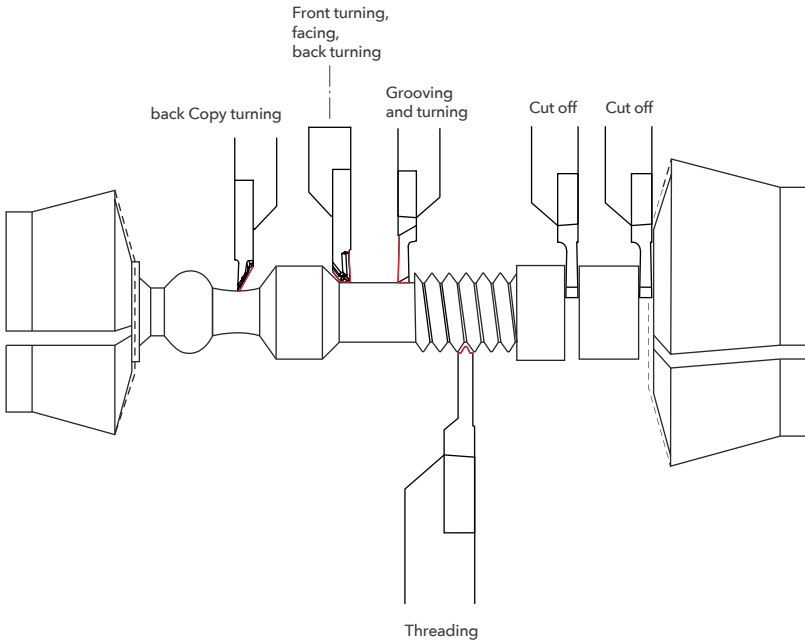
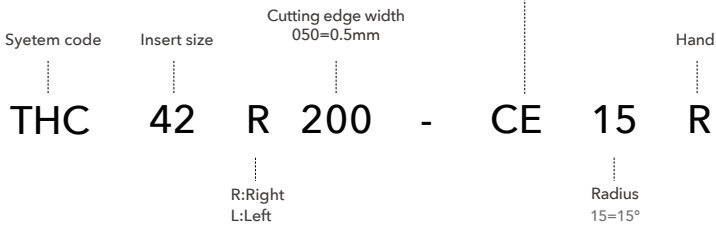
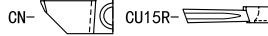
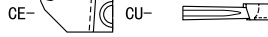



THC42

Parting-off Tools

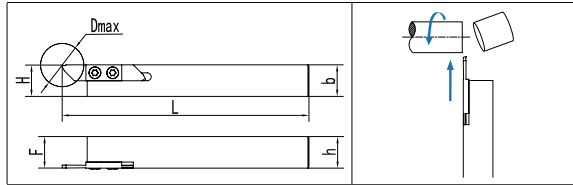

Unit: mm

Specification	Dimensions						Insert Type	Insert Screw	Key
	h	b	H	F	L	Dmax			
THCR1010J42	10	10	10	10	110	23	THC42R**	L60M4*10	T15
THCR1212J42	12	12	12	12	110	23	THC42R**	L60M4*10	T15
THCR1616J42	16	16	16	16	110	23	THC42R**	L60M4*10	T15
THCR2020K42	20	20	20	20	125	23	THC42R**	L60M4*10	T15
THCR2525M42	25	25	25	25	150	23	THC42R**	L60M4*10	T15
THCL1010J42	10	10	10	10	110	23	THC42L**	L60M4*10	T15
THCL1212J42	12	12	12	12	110	23	THC42L**	L60M4*10	T15
THCL1616J42	16	16	16	16	110	23	THC42L**	L60M4*10	T15
THCL2020K42	20	20	20	20	125	23	THC42L**	L60M4*10	T15
THCL2525M42	25	25	25	25	150	23	THC42L**	L60M4*10	T15

Insert see page 54



THC42

Parting-off Insert

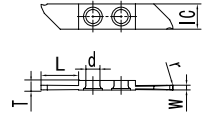

Unit: mm

Right hand	Left hand	IC	d	W	L	r	α	T	Grades	
									NP5700	NU8700
THC42R100-CE	THC42L100-CE	7.94	4.35	1.0	5	0.06	0°	3.07	●	●
THC42R150-CE	THC42L150-CE	7.94	4.35	1.5	8.5	0.06	0°	3.07	●	●
THC42R200-CE	THC42L200-CE	7.94	4.35	2.0	11.5	0.1	0°	3.07	●	●
THC42R250-CE	THC42L250-CE	7.94	4.35	2.5	11.5	0.1	0°	3.07	●	●
THC42R300-CE	THC42L300-CE	7.94	4.35	3.0	11.5	0.2	0°	3.07	●	●
THC42R340-CE	THC42L340-CE	7.94	4.35	3.4	11.5	0.2	0°	3.47	●	●
THC42R100-CE15R	THC42L100-CE15R	7.94	4.35	1.0	5	0.06	15°	3.07	●	●
THC42R150-CE15R	THC42L150-CE15R	7.94	4.35	1.5	8.5	0.06	15°	3.07	●	●
THC42R200-CE15R	THC42L200-CE15R	7.94	4.35	2.0	11.5	0.1	15°	3.07	●	●
THC42R250-CE15R	THC42L250-CE15R	7.94	4.35	2.5	11.5	0.1	15°	3.07	●	●
THC42R300-CE15R	THC42L300-CE15R	7.94	4.35	3.0	11.5	0.2	15°	3.07	●	●
THC42R340-CE15R	THC42L340-CE15R	7.94	4.35	3.4	11.5	0.2	15°	3.47	●	●
THC42R200-CN	THC42L200-CN	7.94	4.35	2.0	11.5	0.1	0°	3.07	●	●
THC42R250-CN	THC42L250-CN	7.94	4.35	2.5	11.5	0.1	0°	3.07	●	●
THC42R300-CN	THC42L300-CN	7.94	4.35	3.0	11.5	0.2	0°	3.07	●	●
THC42R200-CU15R	THC42L200-CU15R	7.94	4.35	2.0	11.5	0.1	15°	3.07	●	●
THC42R250-CU15R	THC42L250-CU15R	7.94	4.35	2.5	11.5	0.1	15°	3.07	●	●
THC42R300-CU15R	THC42L300-CU15R	7.94	4.35	3.0	11.5	0.2	15°	3.07	●	●



Code Key

Chip breaker line-up - MGT insert

KG	M	N	300	04	T
System code KG SYSTEM (KORLOY Grooving)	Tolerance M: Pressed class G: Ground class	Hand N: Neutral R: Right L: Light I: Internal	Width of cutting edge 2.0~8.0mm	Corner nose radius of insert 0.2mm 0.3mm 0.4mm	Chip breaker C/L/R/T LP/RP

Chip breaker line-up - MGT insert

MG	M	N	300	04	T
System code KG SYSTEM (Multi Grooving)	Tolerance M: Pressed class G: Ground class	Hand N: Neutral R: Right L: Light I: Internal	Width of cutting edge 2.0~8.0mm	Corner nose radius of insert 0.2mm 0.3mm 0.4mm	Chip breaker M/G L/R/T

Chip breaker line-up - MGT insert

KG	E	H	R	1212	3	D25A
System code KGT MGT	Application E: External machining I: Internal machining	Holder type H: Horizontal type V: Vertical type U: Undercut type	Hand R: Right L: Light	Shank size Height 12mm, width 12mm (For internal machining: Min. machining diameter)	Cutting width 2.0~3.0mm	Max. cutting diameter Ø15~32mm A: Compact type B: high rigidity type



Chip breaker line-up - KGT insert

KGMM - L

- Sharp cutting edge
- For low feed machining
- For small diameter parts

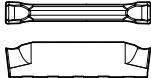

KGMM - R

- Reinforced cutting edge
- For high feed machining
- For interrupted cutting

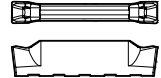

KGMM - T

- Sharp cutting edge
- Stronger chip control
- For turning and grooving



KGMR/L - LP

- Sharp cutting edge
- For low feed machining
- Small diameter component
- Right/Left handed • Low carbon steel

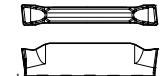

KGMR/L - RP

- Strong cutting edge
- For high feed machining
- For interrupted cutting
- Right/Left handed

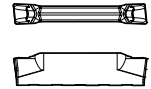

KRMM - C

- Improved chip control
- Copying
- Relief

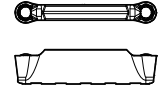

Chip breaker line-up - MGT insert

MGMM-M

- Easier chip control by narrowing chip width with the use of chip breaker on rake surface center
- Smooth chip flow by small dots in external machining
- Available for both external machining and grooving

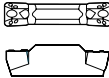

MGMM - G

- Specially designed chip breaker allows narrower chips to promote better chip flow with the use of center dots
- Exclusive chip breaker for grooving

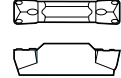



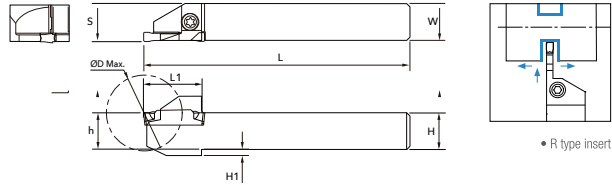

Available tool holders

KGEHR/L Compact type



Unit: mm



Specification	Dimensions							Spare parts		Insert
								Screw	Wrench	
	H	W	L1	L	S	H1	D			
KGEHR/L10102D20A	10	10	19	125	10.2	2	20	ETNA0412	TW15L	KGMN200- - KGMR/L200- - KRMN200-C KRGN200- -
KGEHR/L12122D25A	12	12	19	125	12.2	2	25	ETNA0412	TW15L	
KGEHR/L14142D25A	14	14	19	125	14.2	-	25	ETNA0412	TW15L	
KGEHR/L16162D32A	16	16	24	125	16.2	-	32	ETNA0412	TW15L	
KGEHR/L12123D25A	12	12	19	130	12.4	2	25	ETNA0412	TW15L	KGMN300- - KGMR/L300- - KRMG300-C KRGN300- -
KGEHR/L16163D32A	16	16	24	130	16.4	-	32	ETNA0412	TW15L	

Insert see page 58 

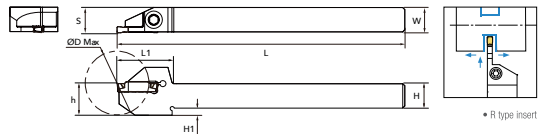
KGEHR/L high rigidity type



Unit: mm

Specification	Dimensions							Spare parts		Insert
								Screw	Wrench	
	H	W	L1	L	S	H1	D			
KGEHR/L10102D30B	10	10	29.6	140	10.2	6.6	30	MHA0512	HW40L	KGMN200- - KGMR/L200- - KRMN200-C KRGN200- -
KGEHR/L12122D25B	12	12	27.1	140	12.2	3.5	25	MHA0512	HW40L	
KGEHR/L12122D30B	12	12	29.6	140	12.2	3.5	30	MHA0512	HW40L	
KGEHR/L16162D32B	16	16	30.6	140	16.2	-	32	MHA0512	HW40L	
KGEHR/L12123D25B	12	12	27.1	140	12.4	3.5	25	MHA0512	HW40L	KGMN300- - KGMR/L300- - KRMG300-C KRGN300- -
KGEHR/L12123D32B	12	12	30.6	140	12.4	3.5	32	MHA0512	HW40L	
KGEHR/L16163D32B	16	16	30.6	140	16.4	-	32	MHA0512	HW40L	

Insert see page 58 



KGT

Applicable inserts

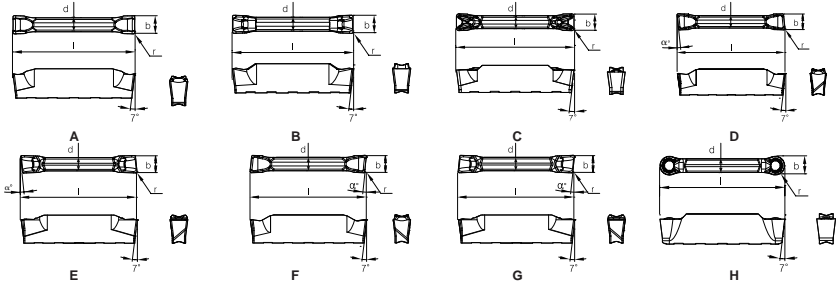

Unit: mm

Specification	Application	Fig.	Dimensions					Coated			
			b	r	ℓ	d	α°	NC3225	NC5330	PC5300	PC9030
KGMM200-02-L	Grooving	A	2	0.2	20	1.7	-	●	●	●	●
KGMM300-02-L	Grooving	A	3	0.2	20	2.3	-	●	●	●	●
KGMM200-02-R	Grooving · Parting off	B	2	0.2	20	1.7	-	●	●	●	●
KGMM300-02-R	Grooving · Parting off	B	3	0.2	20	2.3	-	●	●	●	●
KGMM200-02-T	Grooving · turning	C	2	0.2	20	1.7	-	●	●	●	●
KGMM300-02-T	Grooving · turning	C	3	0.2	20	2.3	-	●	●	●	●
KGMM300-04-T	Grooving · turning	C	3	0.4	20	2.3	-	●	●	●	●
KGMM200-6D-LP	Parting off	D	2	0.2	20	1.7	6		●	●	
KGMR200-15D-LP	Parting off	D	2	0.2	20	1.7	15		●	●	
KGMM200-6D-LP	Parting off	D	3	0.2	20	2.3	6		●	●	
KGMR200-15D-LP	Parting off	D	3	0.2	20	2.3	15		●	●	
KGMR200-6D-RP	Parting off	E	2	0.2	20	1.7	6		●	●	
KGMR200-15D-RP	Parting off	E	2	0.2	20	1.7	15		●	●	
KGMR300-6D-RP	Parting off	E	3	0.2	20	2.3	6		●	●	
KGMR300-15D-RP	Parting off	E	3	0.2	20	2.3	15		●	●	
KGML200-6D-LP	Parting off	F	2	0.2	20	1.7	6				
KGML200-15D-LP	Parting off	F	2	0.2	20	1.7	15				
KGML300-6D-LP	Parting off	F	3	0.2	20	2.3	6				
KGML300-15D-LP	Parting off	F	3	0.2	20	2.3	15				
KGML200-6D-RP	Parting off	G	2	0.2	20	1.7	6				
KGML200-15D-RP	Parting off	G	2	0.2	20	1.7	15				
KGML300-6D-RP	Parting off	G	3	0.2	20	2.3	6				
KGML300-15D-RP	Parting off	G	3	0.2	20	2.3	15				
KRMN200-C	Grooving · Turning	H	2	1	20	1.7	-	●	●	●	
KRMN300-C	Grooving · Turning	H	3	1.5	20	2.2	-	●	●	●	

Recommended cutting data see page 59



Recommended Cutting Data

Grades for recommended application range

Workpiece	Grade	Order of recommended grade	Recommended cutting speed (m/min)					
			50	100	150	200	800	
P	Steel	PC5300		70	120			
		NC3225				130	220	
		NC5330				120	200	
	Alloy Steel	PC5300		60	105			
		NC3225				130	200	
		NC5330			90	180		
M	Stainless steel	PC5300		70	120			
		PC9030		70	115			
		NC5330			75	125		
K	Cast iron	PC5300		55	90			
		NC5330			95	160		
S	H RSA	PC5300	20	35				



S-SVN-N

Round shank / Standard / without side stopper

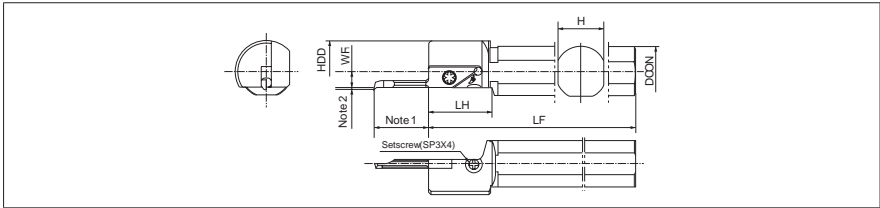

Right-hand shown | Right-hand Insert for Right-hand Toolholder.

Unit: mm

Specification	Dimensions						Spare parts			Insert
							Screw	Set screw	Wrench	
	DCON	H	LH	HDD	LF	WF1				
S12F-SVNR12N	12	11	23	20	80	4	SB3080TR	SP3X4	T10	VNBR..... VNBTR..... VNGR..... VNFR..... VNTR.....
S14G-SVNR12N	14	13	23	20	90	4	SB3080TR	SP3X4	T10	
S16H-SVNR12N	16	15	23	24	100	6	SB3080TR	SP3X4	T10	
S19H-SVNR12N	19.05	17	24	24	100	6	SB3080TR	SP3X4	T10	
S19N-SVNR12N	19.0	17	24	24	160	6	SB3080TR	SP3X4	T10	
S20H-SVNR12N	20	18	24	24	100	6	SB3080TR	SP3X4	T10	
S25H-SVNR12N	25.4	23	24	30	100	6	SB3080TR	SP3X4	T10	
S25Q-SVNR12N	25.4	23	24	30	180	6	SB3080TR	SP3X4	T10	

Insert see page 64-67



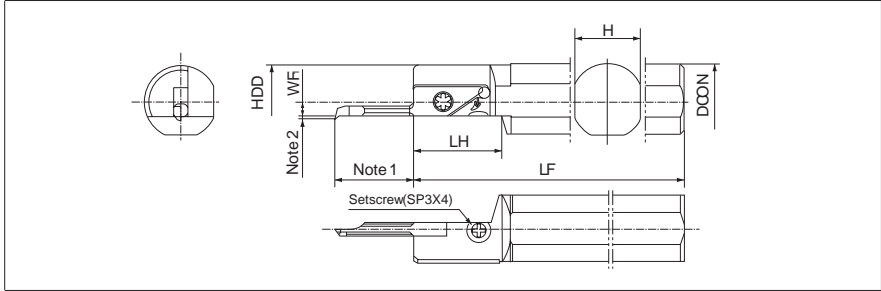

S-SVN-SN

Round shank / Straight / without side stopper



Right-hand shown | Right-hand Insert for Right-hand Toolholder.

Unit: mm

Specification	Dimensions						Spare parts			Insert
							Screw	Set screw	Wrench	
	DCON	H	LH	HDD	LF	WF1				
S19H-SVNR12SN	19.05	17	23	18.5	100	4	SB3080TR	SP3X4	T10	VNBR....., VNBTR... VNFR....., VNFRG... VNTR.....
S20H-SVNR12SN	20	18	23	19.5	100	4	SB3080TR	SP3X4	T10	
S22K-SVNR12SN	22	20	23	21.5	125	4	SB3080TR	SP3X4	T10	
S25G-SVNR12SN	25	23	23	24.5	90	4	SB3080TR	SP3X4	T10	

Insert see page 64-67 



SVN-N

without side stopper

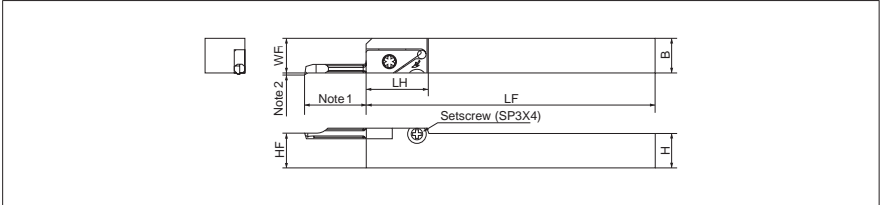

Right-hand shown | Right-hand Insert for Right-hand Toolholder.

Unit: mm

Specification	Dimensions						Spare parts			Insert
							Screw	Set screw	Wrench	
	H	B	LH	HF	LF	WF				
SVNR1010H12N	10	10	22	10	100	10	SB3080TR	SP3X4	T10	VNBR..... VNBTR..... VNGR..... VNFGR..... VNTR.....
SVNR1212K12N	12	12	22	12	125	12	SB3080TR	SP3X4	T10	
SVNR1616K12N	16	16	22	16	125	16	SB3080TR	SP3X4	T10	
SVNR2020K12N	20	20	22	20	125	20	SB3080TR	SP3X4	T10	
SVNR2525M12N	25	25	22	25	150	25	SB3080TR	SP3X4	T10	

Insert see page 64-67



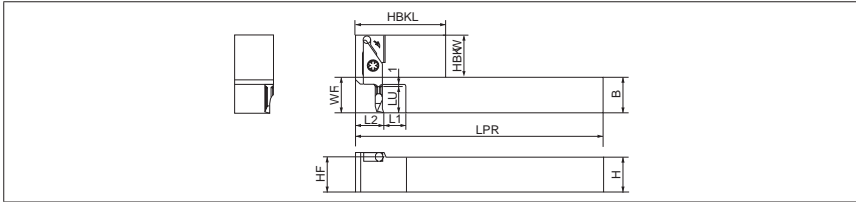

SVNS-N

without side stopper / without setscrew



Right-hand shown | Right-hand Insert for Right-hand Toolholder.

Unit: mm

Specification	Dimensions											Spare parts		Insert
												Screw	Wrench	
	H	B	LPR	HF	HBKW	HBKL	LU	WF1	L1	L2				
SVNSR1010K1206N	10	10	125	10	19	45	6	10	10	12	SB3080TR	LTW10S	VNBR..06...	
SVNSR1212M1206N	12	12	150	12	17	45	6	12	10	12	SB3080TR	LTW10S		
SVNSR1616M1206N	16	16	150	16	13	45	6	16	16	12	SB3080TR	LTW10S		
SVNSR1010K1211N	10	10	125	10	23	45	11	10	10	12	SB3080TR	LTW10S	VNBR..11..., VNBTR..11... VNGR...11, VNTR...11	
SVNSR1212M1211N	12	12	150	12	21	45	11	12	10	12	SB3080TR	LTW10S		
SVNSR1616M1211N	16	16	150	16	17	45	11	16	16	12	SB3080TR	LTW10S		
SVNSR1212M1220N	12	12	150	12	30	45	20	12	10	13	SB3080TR	LTW10S	VNBR..20..., VNBTR20... VNGR...20	
SVNSR1616M1220N	16	16	150	16	26	45	20	16	16	13	SB3080TR	LTW10S		

Insert see page 64-67 



VNB

Boring

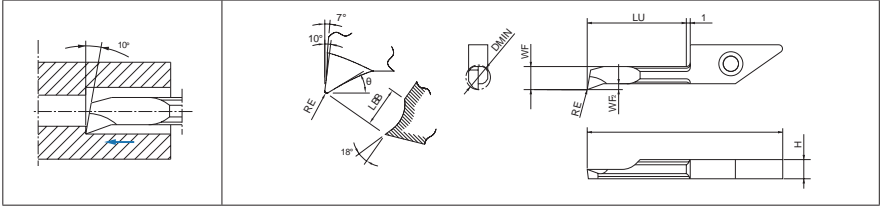

Right-hand shown

Unit: mm

Specification	No.	Dimensions								Angle	Carbide		
		DMIN	H	LBB	LF	LU	WF	WF2	RE	θ(°)	PVD		
											NP9030	NP3030	NP1030
VNBR0206003	1	2	3.9	1.2	26.5	6	1.8	0.25	0.03	24	●	●	●
VNBR020601	1	2	3.9	1.2	26.5	6	1.8	0.25	0.1	24	●	●	●
VNBR020602	1	2	3.9	1.2	26.5	6	1.8	0.25	0.2	24	●	●	●
VNBR0311003	1	3	3.9	1.8	30.8	11	2.6	0.4	0.03	24	●	●	●
VNBR031101	1	3	3.9	1.8	30.8	11	2.6	0.4	0.1	24	●	●	●
VNBR031102	1	3	3.9	1.8	30.8	11	2.6	0.4	0.2	24	●	●	●
VNBR0411003	1	4	3.66	2.7	30.8	11	3.5	0.5	0.03	23	●	●	●
VNBR041101	1	4	3.66	2.7	30.8	11	3.5	0.5	0.1	23	●	●	●
VNBR041102	1	4	3.66	2.7	30.8	11	3.5	0.5	0.2	23	●	●	●
VNBR0420003	1	4	3.66	2.7	39.8	20	3.5	0.5	0.03	23	●	●	●
VNBR042001	1	4	3.66	2.7	39.8	20	3.5	0.5	0.1	23	●	●	●
VNBR042002	1	4	3.66	2.7	39.8	20	3.5	0.5	0.2	23	●	●	●
VNBR0511003	1	5	3.9	3	30.8	11	4.5	0.7	0.03	23	●	●	●
VNBR051101	1	5	3.9	3	30.8	11	4.5	0.7	0.1	23	●	●	●
VNBR051102	1	5	3.9	3	30.8	11	4.5	0.7	0.2	23	●	●	●
VNBR0520003	1	5	3.9	3	39.8	20	4.5	0.7	0.03	23	●	●	●
VNBR052001	1	5	3.9	3	39.8	20	4.5	0.7	0.1	23	●	●	●
VNBR052002	1	5	3.9	3	39.8	20	4.5	0.7	0.2	23	●	●	●
VNBR0620003	1	6	3.9	3	39.8	20	5.3	1	0.03	24	●	●	●
VNBR062001	1	6	3.9	3	39.8	20	5.3	1	0.1	24	●	●	●
VNBR062002	1	6	3.9	3	39.8	20	5.3	1	0.2	24	●	●	●
VNBR0630003	1	6	3.9	3	49.8	30	5.3	1	0.03	24	●	●	●
VNBR063001	1	6	3.9	3	49.8	30	5.3	1	0.1	24	●	●	●
VNBR063002	1	6	3.9	3	49.8	30	5.3	1	0.2	24	●	●	●
VNBR0720003	1	7	3.9	3	39.8	20	6.2	1	0.03	24	●	●	●
VNBR072001	1	7	3.9	3	39.8	20	6.2	1	0.1	24	●	●	●
VNBR072002	1	7	3.9	3	39.8	20	6.2	1	0.2	24	●	●	●
VNBR0730003	1	7	3.9	3	49.8	30	6.2	1	0.03	24	●	●	●
VNBR073001	1	7	3.9	3	49.8	30	6.2	1	0.1	24	●	●	●
VNBR073002	1	7	3.9	3	49.8	30	6.2	1	0.2	24	●	●	●

Recommended cutting data see page 72-73



Turning Indexable Inserts

VNB-S

Boring

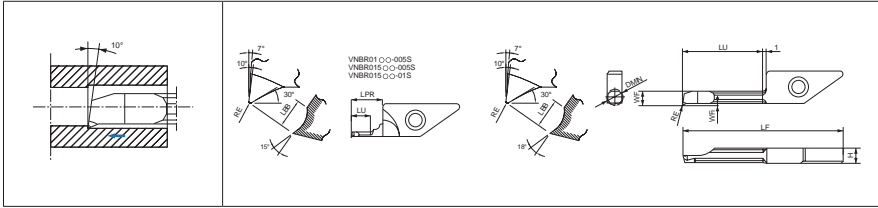

Right-hand shown

Unit: mm

Specification	Dimensions									Tolerance	Carbide	
	DMIN	H	LPR	LBB	LF	LU	WF	WF2	RE	REmin.-max.	NP9030	NP3030
VNBR0103005S	1	3.9	7	0.7	26.5	3	0.85	0.2	0.05	-0.02 - 0	●	●
VNBR0105005S	1	3.9	7	0.7	26.5	5	0.85	0.2	0.05	-0.02 - 0	●	●
VNBR01503005S	1.5	3.9	7	0.7	26.5	3	1.3	0.2	0.05	-0.02 - 0	●	●
VNBR0150301S	1.5	3.9	7	0.7	26.5	3	1.3	0.2	0.1	-0.03 - 0	●	●
VNBR01505005S	1.5	3.9	7	0.7	26.5	5	1.3	0.2	0.05	-0.02 - 0	●	●
VNBR0150501S	1.5	3.9	7	0.7	26.5	5	1.3	0.2	0.1	-0.03 - 0	●	●
VNBR0206005S	2	3.9	-	0.8	26.5	6	1.8	0.25	0.05	-0.02 - 0	●	●
VNBR020601S	2	3.9	-	0.8	26.5	6	1.8	0.25	0.1	-0.03 - 0	●	●
VNBR025075005S	2.5	3.9	-	0.8	28.1	7.5	2.1	0.4	0.05	-0.02 - 0	●	●
VNBR02507501S	2.5	3.9	-	0.8	28.1	7.5	2.1	0.4	0.1	-0.03 - 0	●	●
VNBR0311005S	3	3.9	-	0.8	30.8	11	2.6	0.4	0.05	-0.02 - 0	●	●
VNBR031101S	3	3.9	-	0.8	30.8	11	2.6	0.4	0.1	-0.03 - 0	●	●
VNBR03515005S	3.5	3.9	-	0.8	34.8	15	3	0.5	0.05	-0.02 - 0	●	●
VNBR0351501S	3.5	3.9	-	0.8	34.8	15	3	0.5	0.1	-0.03 - 0	●	●
VNBR0411005S	4	3.66	-	0.8	30.8	11	3.5	0.5	0.05	-0.02 - 0	●	●
VNBR041101S	4	3.66	-	0.8	30.8	11	3.5	0.5	0.1	-0.03 - 0	●	●
VNBR041102S	4	3.66	-	0.8	30.8	11	3.5	0.5	0.2	-0.04 - 0	●	●
VNBR0420005S	4	3.66	-	0.8	39.8	20	3.5	0.5	0.05	-0.02 - 0	●	●
VNBR042001S	4	3.66	-	0.8	39.8	20	3.5	0.5	0.1	-0.03 - 0	●	●
VNBR042002S	4	3.66	-	0.8	39.8	20	3.5	0.5	0.2	-0.04 - 0	●	●

Recommended cutting data see page 72-73



VNB-NB

Boring

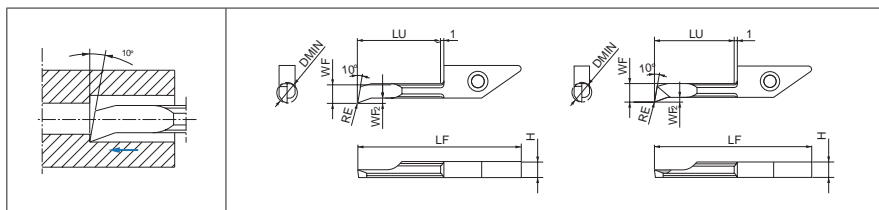

Right-hand shown

Unit: mm

Specification	Dimensions							Angle θ(°)	Carbide		PCD
	DMIN	H	LF	LU	WF	WF2	RE		PVD	-	
								NP3030	NP1030	PCD800	
VNBR0206003NB	2	3.9	26.5	6	1.8	0.25	0.03	15	●	●	
VNBR020602NB	2	3.9	26.5	6	1.8	0.25	0.2	15		●	
VNBR0311003NB	3	3.9	30.8	11	2.6	0.4	0.03	15	●	●	
VNBR031102NB	3	3.9	30.8	11	2.6	0.4	0.2	15		●	
VNBR0411003NB	4	3.66	30.8	11	3.5	0.5	0.03	15	●	●	
VNBR041102NB	4	3.66	30.8	11	3.5	0.5	0.2	15		●	●
VNBR0420003NB	4	3.66	39.8	20	3.5	0.5	0.03	15	●	●	
VNBR042002NB	4	3.66	39.8	20	3.5	0.5	0.2	15		●	●
VNBR0511003NB	5	3.9	30.8	11	4.5	0.7	0.03	15	●	●	
VNBR051102NB	5	3.9	30.8	11	4.5	0.7	0.2	15		●	●
VNBR0520003NB	5	3.9	39.8	20	4.5	0.7	0.03	15	●	●	
VNBR052002NB	5	3.9	39.8	20	4.5	0.7	0.2	15		●	●
VNBR0620003NB	6	3.9	39.8	20	5.3	1	0.03	15	●	●	
VNBR062002NB	6	3.9	39.8	20	5.3	1	0.2	15		●	●
VNBR0630003NB	6	3.9	49.8	30	5.3	1	0.03	15	●	●	
VNBR063002NB	6	3.9	49.8	30	5.3	1	0.2	15		●	●
VNBR0720003NB	7	3.9	39.8	20	6.2	1	0.03	15	●	●	
VNBR072002NB	7	3.9	39.8	20	6.2	1	0.2	15		●	●
VNBR0730003NB	7	3.9	49.8	30	6.2	1	0.03	15	●	●	
VNBR073002NB	7	3.9	49.8	30	6.2	1	0.2	15		●	●

Recommended cutting data see page 72-73



VNBT

Back boring

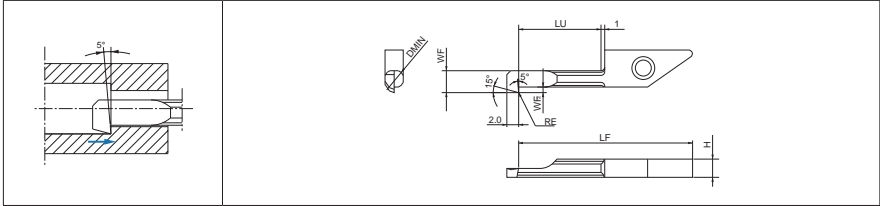

Right-hand shown

Unit: mm

Specification	Dimensions							Carbide		
	DMIN	H	LF	LU	WF	WF2	RE	PVD		-
								NP9030	NP3030	NP1030
VNBTR0411003	4	3.66	28.8	9	3.6	1	0.03		●	●
VNBTR041101	4	3.66	28.8	9	3.6	1	0.1	●	●	●
VNBTR0420003	4	3.66	37.8	15	3.6	1	0.03		●	
VNBTR042001	4	3.66	37.8	18	3.6	1	0.1	●	●	
VNBTR0511003	5	3.9	28.8	9	4.6	1.3	0.03		●	●
VNBTR051101	5	3.9	28.8	9	4.6	1.3	0.1	●	●	●
VNBTR0520003	5	3.9	37.8	18	4.6	1.3	0.03		●	
VNBTR052001	5	3.9	37.8	18	4.6	1.3	0.1	●	●	

Recommended cutting data see page 72-73



SVNS-XN

without side stopper

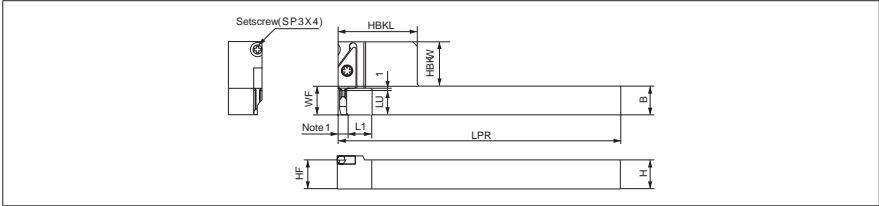

Right-hand shown | Right-hand Insert for Right-hand Toolholder.
 Note 1 : The dimension of Note 1 is same size as the applicable insert (VNBX) WF dimension.

Unit: mm

Specification	Dimensions										Spare parts			Insert
											Screw	Set screw	Wrench	
	H	B	LPR	L1	HF	HBKWL	HBKLV	LU	WF					
SVNSR1010K1206XN	10	10	125	10	10	19	45	6	10	SB3080TR	SP3X4	LTW10S	VNBXR0206-...	
SVNSR1212M1206XN	12	12	150	10	12	17	45	6	12	SB3080TR	SP3X4	LTW10S	VNBXR0206-...	
SVNSR1616M1206XN	16	16	150	16	16	13	45	6	16	SB3080TR	SP3X4	LTW10S	VNBXR0206-...	
SVNSR1010K1211XN	10	10	125	10	10	23	45	11	10	SB3080TR	SP3X4	LTW10S	VNBXR...11-...	
SVNSR1212M1211XN	12	12	150	10	12	21	45	11	12	SB3080TR	SP3X4	LTW10S	VNBXR...11-...	
SVNSR1616M1211XN	16	16	150	16	16	17	45	11	16	SB3080TR	SP3X4	LTW10S	VNBXR...11-...	
SVNSR1212M1220XN	12	12	150	10	12	30	45	20	10	SB3080TR	SP3X4	LTW10S	VNBXR0420-...	
SVNSR1616M1220XN	16	16	150	16	16	26	45	20	16	SB3080TR	SP3X4	LTW10S	VNBXR0420-...	

Insert see page 71



Mini Turn For Small Parts Machining

S-SVN-XN

Round shank / Standard / without side stopper

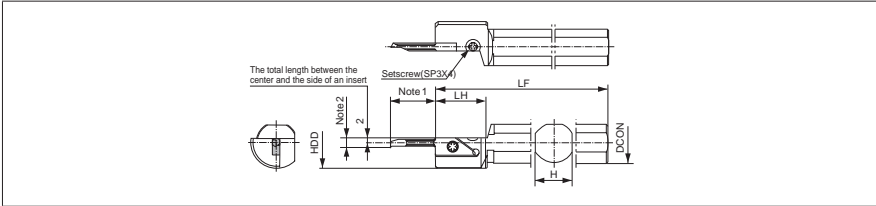



Right-hand shown | Right-hand Insert for Right-hand Toolholder.

Note 1 : The dimension of Note 1 shows the applicable insert (VNBX) LU +1 mm.

Note 2 : The dimension of Note 2 is same size as the applicable insert (VNBX) WF dimension.

Unit: mm

Specification	Dimensions					Spare parts			Insert
						Screw	Set screw	Wrench	
	DCON	H	LH	HDD	LF				
S12F-SVNR12XN	12	11	23	20	80	SB3080TR	SP3X4	T10	VNBXR...
S14G-SVNR12XN	14	13	23	20	90	SB3080TR	SP3X4	T10	VNBXR...
S16H-SVNR12XN	16	15	23	24	100	SB3080TR	SP3X4	T10	VNBXR...
S19H-SVNR12XN	19.05	17	24	24	100	SB3080TR	SP3X4	T10	VNBXR...
S19N-SVNR12XN	19.05	17	24	24	160	SB3080TR	SP3X4	T10	VNBXR...
S20H-SVNR12XN	20	18	24	24	100	SB3080TR	SP3X4	T10	VNBXR...
S25H-SVNR12XN	25.4	23	24	30	100	SB3080TR	SP3X4	T10	VNBXR...
S25Q-SVNR12XN	25.4	23	24	30	180	SB3080TR	SP3X4	T10	VNBXR...

Insert see page 71 



S-SVN-SXN

Round shank / Straight / without side stopper

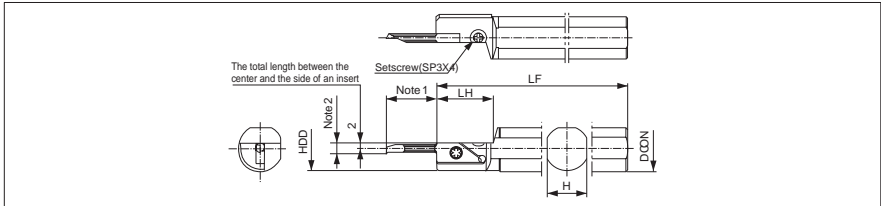

Right-hand shown | Right-hand Insert for Right-hand Toolholder.

Note 1 : The dimension of Note 1 shows the applicable insert (VNBX) LU +1 mm.

Note 2 : The dimension of Note 2 is same size as the applicable insert (VNBX) WF dimension.

Unit: mm

Specification	Dimensions					Spare parts			Insert
						Screw	Set screw	Wrench	
	DCON	H	LH	HDD	LF				
S19H-SVNR12SXN	19.05	17	23	18.5	100	SB3080TR	SP3X4	T10	VNBXR...
S20H-SVNR12SXN	20	18	23	19.5	100	SB3080TR	SP3X4	T10	VNBXR...
S22K-SVNR12SXN	22	20	23	21.5	125	SB3080TR	SP3X4	T10	VNBXR...
S25G-SVNR12SXN	25	23	23	24.5	90	SB3080TR	SP3X4	T10	VNBXR...

Insert see page 71



Turning Indexable Inserts

VNBX-S

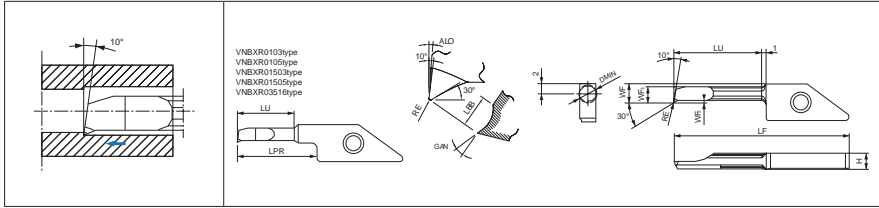

Right-hand shown

Unit: mm

Specification	Dimensions										Angle (°)			Tolerance	Carbide
	DMIN	H	LPR	LBB	LF	LU	WF	WF2	WF3	RE	ALO	GAN	REmin.-max.	NP3030	
VNBXR0103005S	1	3.9	7	0.7	26.5	3	2.95	0.2	0.85	0.05	7	15	-0.02-0	●	
VNBXR0105005S	1	3.9	7	0.7	26.5	5	2.95	0.2	0.85	0.05	7	15	-0.02-0	●	
VNBXR01503005S	1.5	3.9	7	0.7	26.5	3	2.95	0.2	1.3	0.05	7	15	-0.02-0	●	
VNBXR0150301S	1.5	3.9	7	0.7	26.5	3	2.95	0.2	1.3	0.1	7	15	-0.03-0	●	
VNBXR01505005S	1.5	3.9	7	0.7	26.5	5	2.95	0.2	1.3	0.05	7	15	-0.02-0	●	
VNBXR0150501S	1.5	3.9	7	0.7	26.5	5	2.95	0.2	1.3	0.1	7	15	-0.03-0	●	
VNBXR0206005S	2	3.9	-	0.8	26.5	6	3	0.25	1.8	0.05	8	18	-0.02-0	●	
VNBXR020601S	2	3.9	-	0.8	26.5	6	3	0.25	1.8	0.1	8	18	-0.03-0	●	
VNBXR0311005S	3	3.9	-	0.8	30.8	11	3.5	0.4	2.6	0.05	8	18	-0.02-0	●	
VNBXR031101S	3	3.9	-	0.8	30.8	11	3.5	0.4	2.6	0.1	8	18	-0.03-0	●	
VNBXR03511005S	3.5	3.9	-	0.8	30.8	11	3.75	0.45	3.1	0.05	8	18	-0.02-0	●	
VNBXR0351101S	3.5	3.9	-	0.8	30.8	11	3.75	0.45	3.1	0.1	8	18	-0.03-0	●	
VNBXR03516005S	3.5	3.9	21	0.8	39.8	16	3.75	0.45	3.1	0.05	8	18	-0.02-0	●	
VNBXR0351601S	3.5	3.9	21	0.8	39.8	16	3.75	0.45	3.1	0.1	8	18	-0.03-0	●	
VNBXR0411005S	4	3.66	-	0.8	30.8	11	4	0.5	3.5	0.05	8	18	-0.02-0	●	
VNBXR041101S	4	3.66	-	0.8	30.8	11	4	0.5	3.5	0.1	8	18	-0.03-0	●	
VNBXR041102S	4	3.66	-	0.8	30.8	11	4	0.5	3.5	0.2	8	18	-0.04-0	●	
VNBXR0420005S	4	3.66	-	0.8	39.8	20	4	0.5	3.5	0.05	8	18	-0.02-0	●	
VNBXR042001S	4	3.66	-	0.8	39.8	20	4	0.5	3.5	0.1	8	18	-0.03-0	●	
VNBXR042002S	4	3.66	-	0.8	39.8	20	4	0.5	3.5	0.2	8	18	-0.04-0	●	

Recommended cutting data see page 72-73





Selection of system tip-bars

Square shank (Straight)	Square shank (L-shape)	Square shank	Square shank
Round shank (Standard)		Round shank (Standard)	Round shank (Standard)
Round shank (Straight)		Round shank (Straight)	Round shank (Straight)

Recommended Cutting Conditions(VNB-S)

Workpiece material	Insert grades (Vc: m/min)	VNB01-S VNB015-S		VNB02-S - VNB04-S		Remarks
	PVD coated carbide	ap (mm), f (mm/rev)				
	NP3030	ap	f	ap	f	
Carbon steel / Alloy steel	* 30 - 100	-0.1	-0.01	-0.2	-0.03	Coolant
Stainless steel	* 30 - 80	-0.1	-0.01	-0.2	-0.02	

★ 1st recommendation ☆ 2nd recommendation

Recommended Cutting Conditions(VNB-S)

Workpiece material	Insert grades (Vc: m/min)		VNB01-S VNB015-S		VNB02-S - VNB04-S		Remarks
	MEGACOAT	PVD coated carbide	ap (mm), f (mm/rev)				
	NP9030	NP3030	ap	f	ap	f	
Carbon steel / Alloy steel	* 30 - 120	☆ 30 - 100	-0.1	-0.01	-0.2	-0.03	Coolant
Stainless steel	* 30 - 100	☆ 30 - 80	-0.1	-0.01	-0.2	-0.02	

★ 1st recommendation ☆ 2nd recommendation



Recommended Cutting Data

Recommended Cutting Conditions (VNB / VNB-NB / VNBT)

Workpiece material	Insert grades (Vc: m/min)					VNB02		VNB03		VNB04 VNBT04		VNB05 VNB06 VNB07 VNBT05		Remarks
	MEGACOAT	PVD coated carbide	Carbide	PCD										
	NP9030	NP3030	NP1030	PCD800	KPD010	ap (mm), f (mm/rev)								
						ap	f	ap	f	ap	f	ap	f	
Carbon steel / Alloy steel	★ 30 - 120	☆ 30 - 100				-0.3	-0.03	-0.4	-0.04	-0.45	-0.07	-0.5	-0.1	Coolant
Stainless steel	★ 30 - 100	☆ 30 - 80				-0.3	-0.02	-0.4	-0.03	-0.45	-0.05	-0.5	-0.07	
Non-ferrous metals			☆ - 100	★ - 300	☆ - 300	-0.3	-0.05	-0.4	-0.06	-0.45	-0.1	-0.5	-0.15	

★ 1st recommendation ☆ 2nd recommendation



Solid Cutting Tools

SC **N** **R** **1.5** - **5L** - **R0.1** **NP5000**

Series Hand Min Dia. Eff. Length Corner radius Grades



R: Right
L: Left

Application
N - Turning
T - Boring
P - Profiling / Boring
Q - Profiling / Boring
W - Grooving
F - Face Grooving
I - Threading

10 : 10.0
15 : 15.0
20 : 20.0
25 : 25.0
30 : 30.0

XSHB **20** **06**

Holder Holder Dia. Insert Size

20 - 20 mm
25 - 25 mm

04 : 4 mm
05 : 5 mm
06 : 6 mm
08 : 8 mm

Boring

Boring Copying Back Boring Chamfering

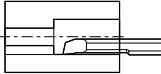
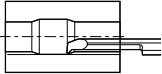
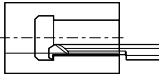
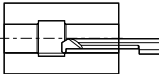
Grooving

Square Grooving Round Grooving Face Grooving

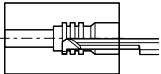
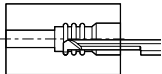
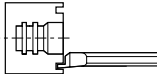
Threading

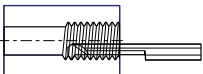

Threading



Solid Cutting Tools For Micro Machining

SCNR

Boring

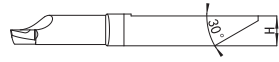
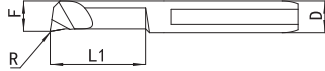
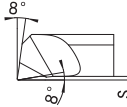
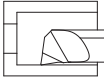

Unit: mm

Specification	F	L1	S	R	D	H	Min. Dia	NP5000	NP9000	NP1000	NU8000
SCNR1.5-5L-R0.1	1.3	5	0.3	0.1	D4	3.7	1.5	○	●	○	●
SCNR2-5L-R0.1	1.8	5	0.3	0.1	D4	3.7	2.0	○	●	○	●
SCNR2-10L-R0.1	1.8	10	0.3	0.1	D4	3.7	2.0	○	●	○	●
SCNR2.5-5L-R0.1	2.3	5	0.3	0.1	D4	3.7	2.5	○	●	○	●
SCNR2.5-10L-R0.1	2.3	10	0.3	0.1	D4	3.7	2.5	○	●	○	●
SCNR3-10L-R0.1	2.8	10	0.4	0.1	D4	3.7	3.0	○	●	○	●
SCNR3-10L-R0.2	2.8	10	0.4	0.2	D4	3.7	3.0	○	●	○	●
SCNR3-15L-R0.1	2.8	15	0.4	0.1	D4	3.7	3.0	○	●	○	●
SCNR3-15L-R0.2	2.8	15	0.4	0.2	D4	3.7	3.0	○	●	○	●
SCNR3.5-10L-R0.1	3.3	10	0.4	0.1	D4	3.7	3.5	○	●	○	●
SCNR3.5-10L-R0.2	3.3	10	0.4	0.2	D4	3.7	3.5	○	●	○	●
SCNR3.5-15L-R0.1	3.3	15	0.4	0.1	D4	3.7	3.5	○	●	○	●
SCNR3.5-15L-R0.2	3.3	15	0.4	0.2	D4	3.7	3.5	○	●	○	●
SCNR4-10L-R0.1	3.8	10	0.5	0.1	D4	3.7	4.0	○	●	○	●
SCNR4-10L-R0.2	3.8	10	0.5	0.2	D4	3.7	4.0	○	●	○	●
SCNR4-15L-R0.1	3.8	15	0.5	0.1	D4	3.7	4.0	○	●	○	●
SCNR4-15L-R0.2	3.8	15	0.5	0.2	D4	3.7	4.0	○	●	○	●
SCNR4-20L-R0.1	3.8	20	0.5	0.1	D4	3.7	4.0	○	●	○	●
SCNR4-20L-R0.2	3.8	20	0.5	0.2	D4	3.7	4.0	○	●	○	●

● Stock ○ Available Upon Order

P	△	▲	△	▲
M	▲	▲	△	△
K	△	△	△	△
N	△	△		▲
S	△	△	▲	
H	△	△	▲	

Holders see page 88





SCNR

Boring

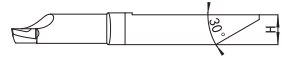
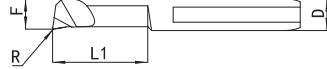
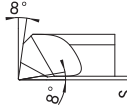
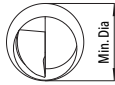
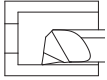

Unit: mm

Specification	F	L1	S	R	D	H	Min. Dia	NPS000	NP9000	NP1000	NU8000
SCNR5-10L-R0.1	4.8	10	0.5	0.1	D5	4.7	5	○	●	○	●
SCNR5-10L-R0.2	4.8	10	0.5	0.2	D5	4.7	5	○	●	○	●
SCNR5-15L-R0.1	4.8	15	0.5	0.1	D5	4.7	5	○	●	○	●
SCNR5-15L-R0.2	4.8	15	0.5	0.2	D5	4.7	5	○	●	○	●
SCNR5-20L-R0.1	4.8	20	0.5	0.1	D5	4.7	5	○	●	○	●
SCNR5-20L-R0.2	4.8	20	0.5	0.2	D5	4.7	5	○	●	○	●
SCNR5-30L-R0.1	4.8	30	0.5	0.1	D5	4.7	5	○	●	○	●
SCNR5-30L-R0.2	4.8	30	0.5	0.2	D5	4.7	5	○	●	○	●
SCNR6-10L-R0.1	5.8	10	0.5	0.1	D6	5.7	6	○	●	○	●
SCNR6-10L-R0.2	5.8	10	0.5	0.2	D6	5.7	6	○	●	○	●
SCNR6-15L-R0.1	5.8	15	0.5	0.1	D6	5.7	6	○	●	○	●
SCNR6-15L-R0.2	5.8	15	0.5	0.2	D6	5.7	6	○	●	○	●
SCNR6-20L-R0.1	5.8	20	0.5	0.1	D6	5.7	6	○	●	○	●
SCNR6-20L-R0.2	5.8	20	0.5	0.2	D6	5.7	6	○	●	○	●
SCNR6-30L-R0.1	5.8	30	0.5	0.1	D6	5.7	6	○	●	○	●
SCNR6-30L-R0.2	5.8	30	0.5	0.2	D6	5.7	6	○	●	○	●
SCNR8-15L-R0.2	7.8	15	0.6	0.2	D8	7.6	8	○	●	○	●
SCNR8-20L-R0.2	7.8	20	0.6	0.2	D8	7.6	8	○	●	○	●
SCNR8-30L-R0.2	7.8	30	0.6	0.2	D8	7.6	8	○	●	○	●

● Stock ○ Available Upon Order

P	△	▲	△	▲
M	▲	▲	△	△
K	△	△	△	△
N	△	△		▲
S	△	△	▲	
H	△	△	▲	

Holders see page 88



Solid Cutting Tools For Micro Machining

SCTR

Boring

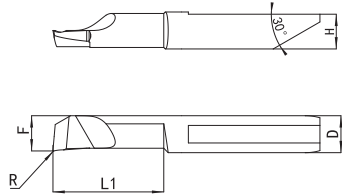
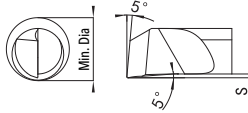
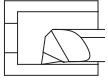

Unit: mm

Specification	F	L1	S	R	D	H	Min. Dia	NP5000	NP9000	NP1000	NP8000
SCTR1.5-5L-R0.1	1.3	5	0.2	0.1	D4	3.7	1.5	○	●	○	●
SCTR2-5L-R0.1	1.8	5	0.2	0.1	D4	3.7	2.0	○	●	○	●
SCTR2-10L-R0.1	1.8	10	0.2	0.1	D4	3.7	2.0	○	●	○	●
SCTR2.5-5L-R0.1	2.3	5	0.2	0.1	D4	3.7	2.5	○	●	○	●
SCTR2.5-10L-R0.1	2.3	10	0.2	0.1	D4	3.7	2.5	○	●	○	●
SCTR3-10L-R0.1	2.8	10	0.3	0.1	D4	3.7	3.0	○	●	○	●
SCTR3-10L-R0.2	2.8	10	0.3	0.2	D4	3.7	3.0	○	●	○	●
SCTR3-15L-R0.1	2.8	15	0.3	0.1	D4	3.7	3.0	○	●	○	●
SCTR3-15L-R0.2	2.8	15	0.3	0.2	D4	3.7	3.0	○	●	○	●
SCTR3.5-10L-R0.1	3.3	10	0.3	0.1	D4	3.7	3.5	○	●	○	●
SCTR3.5-10L-R0.2	3.3	10	0.3	0.2	D4	3.7	3.5	○	●	○	●
SCTR3.5-15L-R0.1	3.3	15	0.3	0.1	D4	3.7	3.5	○	●	○	●
SCTR3.5-15L-R0.2	3.3	15	0.3	0.2	D4	3.7	3.5	○	●	○	●
SCTR4-10L-R0.1	3.8	10	0.4	0.1	D4	3.7	4.0	○	●	○	●
SCTR4-10L-R0.2	3.8	10	0.4	0.2	D4	3.7	4.0	○	●	○	●
SCTR4-15L-R0.1	3.8	15	0.4	0.1	D4	3.7	4.0	○	●	○	●
SCTR4-15L-R0.2	3.8	15	0.4	0.2	D4	3.7	4.0	○	●	○	●
SCTR4-20L-R0.1	3.8	20	0.4	0.1	D4	3.7	4.0	○	●	○	●
SCTR4-20L-R0.2	3.8	20	0.4	0.2	D4	3.7	4.0	○	●	○	●

● Stock ○ Available Upon Order

P	△	▲	△	▲
M	▲	▲	△	△
K	△	△	△	△
N	△	△		▲
S	△	△	▲	
H	△	△	▲	

Holders see page 88





SCTR

Boring

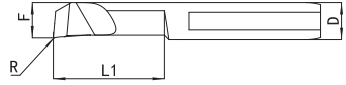
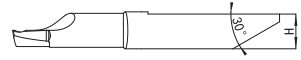
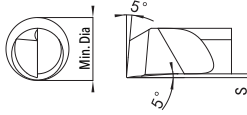
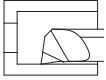

Unit: mm

Specification	F	L1	S	R	D	H	Min. Dia	NP5000	NP9000	NP1000	NU8000
SCTR5-10L-R0.1	4.8	10	0.4	0.1	D5	4.7	5	○	●	○	●
SCTR5-10L-R0.2	4.8	10	0.4	0.2	D5	4.7	5	○	●	○	●
SCTR5-15L-R0.1	4.8	15	0.4	0.1	D5	4.7	5	○	●	○	●
SCTR5-15L-R0.2	4.8	15	0.4	0.2	D5	4.7	5	○	●	○	●
SCTR5-20L-R0.1	4.8	20	0.4	0.1	D5	4.7	5	○	●	○	●
SCTR5-20L-R0.2	4.8	20	0.4	0.2	D5	4.7	5	○	●	○	●
SCTR5-30L-R0.1	4.8	30	0.4	0.1	D5	4.7	5	○	●	○	●
SCTR5-30L-R0.2	4.8	30	0.4	0.2	D5	4.7	5	○	●	○	●
SCTR6-10L-R0.1	5.8	10	0.4	0.1	D6	5.7	6	○	●	○	●
SCTR6-10L-R0.2	5.8	10	0.4	0.2	D6	5.7	6	○	●	○	●
SCTR6-15L-R0.1	5.8	15	0.4	0.1	D6	5.7	6	○	●	○	●
SCTR6-15L-R0.2	5.8	15	0.4	0.2	D6	5.7	6	○	●	○	●
SCTR6-20L-R0.1	5.8	20	0.4	0.1	D6	5.7	6	○	●	○	●
SCTR6-20L-R0.2	5.8	20	0.4	0.2	D6	5.7	6	○	●	○	●
SCTR6-30L-R0.1	5.8	30	0.4	0.1	D6	5.7	6	○	●	○	●
SCTR6-30L-R0.2	5.8	30	0.4	0.2	D6	5.7	6	○	●	○	●
SCTR8-15L-R0.2	7.8	15	0.6	0.2	D8	7.6	8	○	●	○	●
SCTR8-20L-R0.2	7.8	20	0.6	0.2	D8	7.6	8	○	●	○	●
SCTR8-30L-R0.2	7.8	30	0.6	0.2	D8	7.6	8	○	●	○	●

● Stock ○ Available Upon Order

P	△	▲	△	▲
M	▲	▲	△	△
K	△	△	△	△
N	△	△		▲
S	△	△	▲	
H	△	△	▲	

Holders see page 88



Solid Cutting Tools For Micro Machining

SCPR

Profiling and Boring

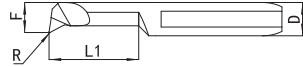
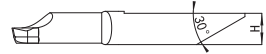
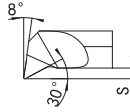
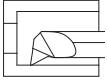

Unit: mm

Specification	F	L1	S	R	D	H	Min. Dia	NP5000	NP9000	NP1000	NP8000
SCPR1.5-5L-R0.1	1.3	5	0.2	0.1	D4	3.7	1.5	○	●	○	●
SCPR2-5L-R0.1	1.8	5	0.3	0.1	D4	3.7	2.0	○	●	○	●
SCPR2-10L-R0.1	1.8	10	0.3	0.1	D4	3.7	2.0	○	●	○	●
SCPR2.5-5L-R0.1	2.3	5	0.3	0.1	D4	3.7	2.5	○	●	○	●
SCPR2.5-10L-R0.1	2.3	10	0.3	0.1	D4	3.7	2.5	○	●	○	●
SCPR3-10L-R0.1	2.8	10	0.3	0.1	D4	3.7	3.0	○	●	○	●
SCPR3-10L-R0.2	2.8	10	0.3	0.2	D4	3.7	3.0	○	●	○	●
SCPR3-15L-R0.1	2.8	15	0.3	0.1	D4	3.7	3.0	○	●	○	●
SCPR3-15L-R0.2	2.8	15	0.3	0.2	D4	3.7	3.0	○	●	○	●
SCPR3.5-10L-R0.1	3.3	10	0.4	0.1	D4	3.7	3.5	○	●	○	●
SCPR3.5-10L-R0.2	3.3	10	0.4	0.2	D4	3.7	3.5	○	●	○	●
SCPR3.5-15L-R0.1	3.3	15	0.4	0.1	D4	3.7	3.5	○	●	○	●
SCPR3.5-15L-R0.2	3.3	15	0.4	0.2	D4	3.7	3.5	○	●	○	●
SCPR4-10L-R0.1	3.8	10	0.7	0.1	D4	3.7	4.0	○	●	○	●
SCPR4-10L-R0.2	3.8	10	0.7	0.2	D4	3.7	4.0	○	●	○	●
SCPR4-15L-R0.1	3.8	15	0.7	0.1	D4	3.7	4.0	○	●	○	●
SCPR4-15L-R0.2	3.8	15	0.7	0.2	D4	3.7	4.0	○	●	○	●
SCPR4-20L-R0.1	3.8	20	0.7	0.1	D4	3.7	4.0	○	●	○	●
SCPR4-20L-R0.2	3.8	20	0.7	0.2	D4	3.7	4.0	○	●	○	●

● Stock ○ Available Upon Order

P	△	▲	△	▲
M	▲	▲	△	△
K	△	△	△	△
N	△	△		▲
S	△	△	▲	
H	△	△	▲	

Holders see page 88





SCPR

Profiling and Boring

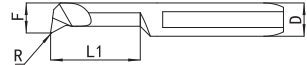
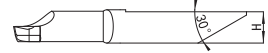
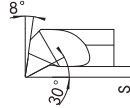
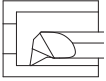

Unit: mm

Specification	F	L1	S	R	D	H	Min. Dia	NP5000	NP9000	NP1000	NU8000
SCPR5-10L-R0.1	4.8	10	0.4	0.1	D5	4.7	5	○	●	○	●
SCPR5-10L-R0.2	4.8	10	0.4	0.2	D5	4.7	5	○	●	○	●
SCPR5-15L-R0.1	4.8	15	0.4	0.1	D5	4.7	5	○	●	○	●
SCPR5-15L-R0.2	4.8	15	0.4	0.2	D5	4.7	5	○	●	○	●
SCPR5-20L-R0.1	4.8	20	0.4	0.1	D5	4.7	5	○	●	○	●
SCPR5-20L-R0.2	4.8	20	0.4	0.2	D5	4.7	5	○	●	○	●
SCPR5-30L-R0.1	4.8	30	0.4	0.1	D5	4.7	5	○	●	○	●
SCPR5-30L-R0.2	4.8	30	0.4	0.2	D5	4.7	5	○	●	○	●
SCPR6-10L-R0.1	5.8	10	0.4	0.1	D6	5.7	6	○	●	○	●
SCPR6-10L-R0.2	5.8	10	0.4	0.2	D6	5.7	6	○	●	○	●
SCPR6-15L-R0.1	5.8	15	0.4	0.1	D6	5.7	6	○	●	○	●
SCPR6-15L-R0.2	5.8	15	0.4	0.2	D6	5.7	6	○	●	○	●
SCPR6-20L-R0.1	5.8	20	0.4	0.1	D6	5.7	6	○	●	○	●
SCPR6-20L-R0.2	5.8	20	0.4	0.2	D6	5.7	6	○	●	○	●
SCPR6-30L-R0.1	5.8	30	0.4	0.1	D6	5.7	6	○	●	○	●
SCPR6-30L-R0.2	5.8	30	0.4	0.2	D6	5.7	6	○	●	○	●
SCPR8-15L-R0.2	7.8	15	0.6	0.2	D8	7.6	8	○	●	○	●
SCPR8-20L-R0.2	7.8	20	0.6	0.2	D8	7.6	8	○	●	○	●
SCPR8-30L-R0.2	7.8	30	0.6	0.2	D8	7.6	8	○	●	○	●

● Stock ○ Available Upon Order

P	△	▲	△	▲
M	▲	▲	△	△
K	△	△	△	△
N	△	△		▲
S	△	△	▲	
H	△	△	▲	

Holders see page 88



Solid Cutting Tools For Micro Machining

SCQR

Profiling and Boring

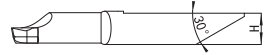
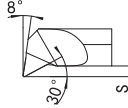
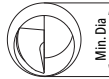
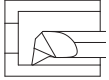

Unit: mm

Specification	F	L1	S	R	D	H	Min. Dia	NPS000	NPS000	NPT000	NU8000
SCQR1.5-5L-R0.1	1.3	5	0.3	0.1	D4	3.7	1.5	○	●	○	●
SCQR2-5L-R0.1	1.8	5	0.3	0.1	D4	3.7	2.0	○	●	○	●
SCQR2-10L-R0.1	1.8	10	0.3	0.1	D4	3.7	2.0	○	●	○	●
SCQR2.5-5L-R0.1	2.3	5	0.3	0.1	D4	3.7	2.5	○	●	○	●
SCQR2.5-10L-R0.1	2.3	10	0.3	0.1	D4	3.7	2.5	○	●	○	●
SCQR3-10L-R0.1	2.8	10	0.6	0.1	D4	3.7	3.0	○	●	○	●
SCQR3-10L-R0.2	2.8	10	0.6	0.2	D4	3.7	3.0	○	●	○	●
SCQR3-15L-R0.1	2.8	15	0.6	0.1	D4	3.7	3.0	○	●	○	●
SCQR3-15L-R0.2	2.8	15	0.6	0.2	D4	3.7	3.0	○	●	○	●
SCQR3.5-10L-R0.1	3.3	10	0.8	0.1	D4	3.7	3.5	○	●	○	●
SCQR3.5-10L-R0.2	3.3	10	0.8	0.2	D4	3.7	3.5	○	●	○	●
SCQR3.5-15L-R0.1	3.3	15	0.8	0.1	D4	3.7	3.5	○	●	○	●
SCQR3.5-15L-R0.2	3.3	15	0.8	0.2	D4	3.7	3.5	○	●	○	●
SCQR4-10L-R0.1	3.8	10	0.8	0.1	D4	3.7	4.0	○	●	○	●
SCQR4-10L-R0.2	3.8	10	0.8	0.2	D4	3.7	4.0	○	●	○	●
SCQR4-15L-R0.1	3.8	15	0.8	0.1	D4	3.7	4.0	○	●	○	●
SCQR4-15L-R0.2	3.8	15	0.8	0.2	D4	3.7	4.0	○	●	○	●
SCQR4-20L-R0.1	3.8	20	0.8	0.1	D4	3.7	4.0	○	●	○	●
SCQR4-20L-R0.2	3.8	20	0.8	0.2	D4	3.7	4.0	○	●	○	●

● Stock ○ Available Upon Order

P	△	▲	△	▲
M	▲	▲	△	△
K	△	△	△	△
N	△	△		▲
S	△	△	▲	
H	△	△	▲	

Holders see page 88





SCQR

Profiling and Boring

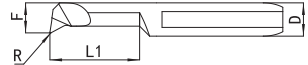
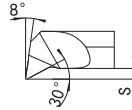
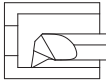
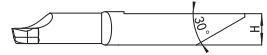

Unit: mm

Specification	F	L1	S	R	D	H	Min. Dia	NP5000	NP9000	NP1000	NU8000
SCQR5-10L-R0.1	4.8	10	1.2	0.1	D5	4.7	5	○	●	○	●
SCQR5-10L-R0.2	4.8	10	1.2	0.2	D5	4.7	5	○	●	○	●
SCQR5-15L-R0.1	4.8	15	1.2	0.1	D5	4.7	5	○	●	○	●
SCQR5-15L-R0.2	4.8	15	1.2	0.2	D5	4.7	5	○	●	○	●
SCQR5-20L-R0.1	4.8	20	1.2	0.1	D5	4.7	5	○	●	○	●
SCQR5-20L-R0.2	4.8	20	1.2	0.2	D5	4.7	5	○	●	○	●
SCQR5-30L-R0.1	4.8	30	1.2	0.1	D5	4.7	5	○	●	○	●
SCQR5-30L-R0.2	4.8	30	1.2	0.2	D5	4.7	5	○	●	○	●
SCQR6-10L-R0.1	5.8	10	1.2	0.1	D6	5.7	6	○	●	○	●
SCQR6-10L-R0.2	5.8	10	1.2	0.2	D6	5.7	6	○	●	○	●
SCQR6-15L-R0.1	5.8	15	1.2	0.1	D6	5.7	6	○	●	○	●
SCQR6-15L-R0.2	5.8	15	1.2	0.2	D6	5.7	6	○	●	○	●
SCQR6-20L-R0.1	5.8	20	1.2	0.1	D6	5.7	6	○	●	○	●
SCQR6-20L-R0.2	5.8	20	1.2	0.2	D6	5.7	6	○	●	○	●
SCQR6-30L-R0.1	5.8	30	1.2	0.1	D6	5.7	6	○	●	○	●
SCQR6-30L-R0.2	5.8	30	1.2	0.2	D6	5.7	6	○	●	○	●
SCQR8-15L-R0.2	7.8	15	1.6	0.2	D8	7.6	8	○	●	○	●
SCQR8-20L-R0.2	7.8	20	1.6	0.2	D8	7.6	8	○	●	○	●
SCQR8-30L-R0.2	7.8	30	1.6	0.2	D8	7.6	8	○	●	○	●

● Stock ○ Available Upon Order

P	△	▲	△	▲
M	▲	▲	△	△
K	△	△	△	△
N	△	△		▲
S	△	△	▲	
H	△	△	▲	

Holders see page 88



Solid Cutting Tools For Micro Machining

SCWR Grooving

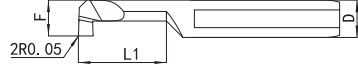
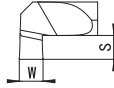
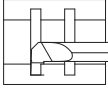
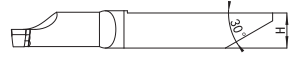

Unit: mm

Specification	F	S	L1	F	D	H	Min. Dia	NP5000	NP9000	NP1000	NU8000
SCWR4-5L-W0.5	0.5	1	5	3.8	D4	3.7	4	○	●	○	●
SCWR4-10L-W0.5	0.5	1	10	3.8	D4	3.7	4	○	●	○	●
SCWR4-5L-W1.0	1	1	5	3.8	D4	3.7	4	○	●	○	●
SCWR4-10L-W1.0	1	2	10	3.8	D4	3.7	4	○	●	○	●
SCWR5-10L-W1.0	1	2	10	4.8	D5	4.7	5	○	●	○	●
SCWR5-20L-W1.0	1	2	20	4.8	D5	4.7	5	○	●	○	●
SCWR5-10L-W1.5	1.5	2	10	4.8	D5	4.7	5	○	●	○	●
SCWR5-20L-W1.5	1.5	2	20	4.8	D5	4.7	5	○	●	○	●
SCWR5-10L-W2.0	2	2	10	4.8	D5	4.7	5	○	●	○	●
SCWR5-20L-W2.0	2	2	20	4.8	D5	4.7	5	○	●	○	●
SCWR6-10L-W1.0	1	1	10	5.8	D6	5.7	6	○	●	○	●
SCWR6-20L-W1.0	1	1	20	5.8	D6	5.7	6	○	●	○	●
SCWR6-10L-W1.5	1.5	1.5	10	5.8	D6	5.7	6	○	●	○	●
SCWR6-20L-W1.5	1.5	1.5	20	5.8	D6	5.7	6	○	●	○	●
SCWR6-10L-W2.0	2	2	10	5.8	D6	5.7	6	○	●	○	●
SCWR6-20L-W2.0	2	2	20	5.8	D6	5.7	6	○	●	○	●
SCWR8-10L-W1.0	1	1	10	7.8	D8	7.7	8	○	●	○	●
SCWR8-20L-W1.0	1	1	20	7.8	D8	7.7	8	○	●	○	●
SCWR8-10L-W1.5	1.5	1.5	10	7.8	D8	7.7	8	○	●	○	●
SCWR8-20L-W1.5	1.5	1.5	20	7.8	D8	7.7	8	○	●	○	●
SCWR8-10L-W2.0	2	2	10	7.8	D8	7.7	8	○	●	○	●
SCWR8-20L-W2.0	2	2	20	7.8	D8	7.7	8	○	●	○	●
SCWR8-10L-W3.0	3	3	10	7.8	D8	7.7	8	○	●	○	●
SCWR8-20L-W3.0	3	3	20	7.8	D8	7.7	8	○	●	○	●

● Stock ○ Available Upon Order

P	△	▲	△	▲
M	▲	▲	△	△
K	△	△	△	△
N	△	△		▲
S	△	△	▲	
H	△	△	▲	

Holders see page 88





SCFL

Face Grooving

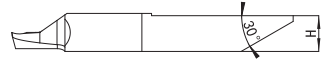
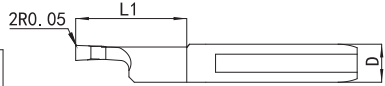
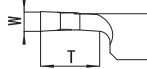
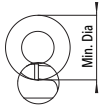
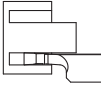

Unit: mm

Specification	W	T	L1	D	H	Min. Dia	NP5000	NP9000	NP1000	NU8000
SCFL4-15L-W0.5	0.5	1.5	15	D4	3.7	6.0	○	●	○	●
SCFL4-15L-W0.75	0.75	2.5	15	D4	3.7	6.0	○	●	○	●
SCFL4-15L-W1.0	1.0	3.0	15	D4	3.7	6.0	○	●	○	●
SCFL5-15L-W1.0	1.0	3.0	15	D5	4.7	8.0	○	●	○	●
SCFL5-15L-W1.5	1.5	4.5	15	D5	4.7	8.0	○	●	○	●
SCFL5-15L-W2.0	2.0	6.0	15	D5	4.7	8.0	○	●	○	●
SCFL6-15L-W1.0	1.0	3.0	15	D6	5.7	10.0	○	●	○	●
SCFL6-15L-W1.5	1.5	4.5	15	D6	5.7	10.0	○	●	○	●
SCFL6-15L-W2.0	2.0	6.0	15	D6	5.7	10.0	○	●	○	●
SCFL8-15L-W1.0	1.0	3.0	15	D8	7.7	15.0	○	●	○	●
SCFL8-15L-W1.5	1.5	4.5	15	D8	7.7	15.0	○	●	○	●
SCFL8-15L-W2.0	2.0	6.0	15	D8	7.7	15.0	○	●	○	●
SCFL8-15L-W2.5	2.5	7.5	15	D8	7.7	15.0	○	●	○	●
SCFL8-15L-W3.0	3.0	9.0	15	D8	7.7	15.0	○	●	○	●

● Stock ○ Available Upon Order

P	△	▲	△	▲
M	▲	▲	△	△
K	△	△	△	△
N	△	△		▲
S	△	△	▲	
H	△	△	▲	

Holders see page 88



Solid Cutting Tools For Micro Machining

SCFR

Face Grooving

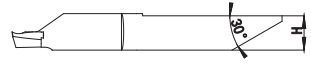
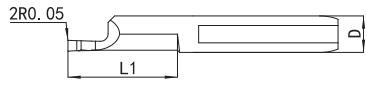
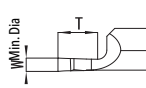
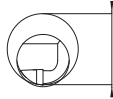
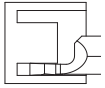

Unit: mm

Specification	W	T	L1	D	H	Min. Dia	NP5000	NP9000	NP1000	NU6000
SCFR4-15L-W0.5	0.5	1.5	15	D4	3.7	6.0	○	●	○	●
SCFR4-15L-W0.75	0.75	2.5	15	D4	3.7	6.0	○	●	○	●
SCFR4-15L-W1.0	1.0	3.0	15	D4	3.7	6.0	○	●	○	●
SCFR5-15L-W1.0	1.0	3.0	15	D5	4.7	8.0	○	●	○	●
SCFR5-15L-W1.5	1.5	4.5	15	D5	4.7	8.0	○	●	○	●
SCFR5-15L-W2.0	2.0	6.0	15	D5	4.7	8.0	○	●	○	●
SCFR6-15L-W1.0	1.0	3.0	15	D6	5.7	10.0	○	●	○	●
SCFR6-15L-W1.5	1.5	4.5	15	D6	5.7	10.0	○	●	○	●
SCFR6-15L-W2.0	2.0	6.0	15	D6	5.7	10.0	○	●	○	●
SCFR8-15L-W1.0	1.0	3.0	15	D8	7.7	15.0	○	●	○	●
SCFR8-15L-W1.5	1.5	4.5	15	D8	7.7	15.0	○	●	○	●
SCFR8-15L-W2.0	2.0	6.0	15	D8	7.7	15.0	○	●	○	●
SCFR8-15L-W2.5	2.5	7.5	15	D8	7.7	15.0	○	●	○	●
SCFR8-15L-W3.0	3.0	9.0	15	D8	7.7	15.0	○	●	○	●

● Stock ○ Available Upon Order

P	△	▲	△	▲
M	▲	▲	△	△
K	△	△	△	△
N	△	△		▲
S	△	△	▲	
H	△	△	▲	

Holders see page 88



SCIR

60° Threading

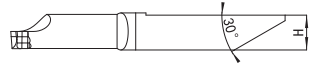
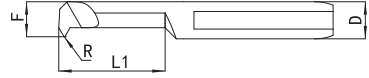
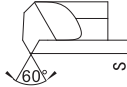
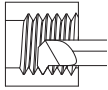

Unit: mm

Specification	F	S	L1	R	D	H	pitch	Threads	Min. Dia	NP5000	NP9000	NP1000	NU8000	
SCIR2-5L-A60	1.9	0.7	5	0.05	D4	3.7	0.35-0.6	56-32	2.0	○	●	○	●	
SCIR3-10L-A60	3.0	1.0	10	0.05	D4	3.7	0.8-1.0	32-24	3.1	○	●	○	●	
SCIR4-10L-A60	3.8	1.0	10	0.05	D4	3.7	0.8-1.0	32-24	4.0	○	●	○	●	
SCIR4-15L-A60	3.8	1.0	15	0.05	D4	3.7	0.8-1.0	32-24	4.0	○	●	○	●	
SCIR5-10L-A60	4.8	1.3	10	0.1	D5	4.7	1.0-1.25	24-20	5.0	○	●	○	●	
SCIR5-15L-A60	4.8	1.3	15	0.1	D5	4.7	1.0-1.25	24-20	5.0	○	●	○	●	
SCIR6-10L-A60	5.6	1.5	10	0.1	D6	5.7	1.0-1.5	24-16	6.0	○	●	○	●	
SCIR6-15L-A60	5.6	1.5	15	0.1	D6	5.7	1.0-1.5	24-16	6.0	○	●	○	●	
SCIR8-10L-A60	7.6	1.8	10	0.1	D8	7.7	1.0-2.0	24-13	8.0	○	●	○	●	
SCIR8-20L-A60	7.6	1.8	20	0.1	D8	7.7	1.0-2.0	24-13	8.0	○	●	○	●	
										P	△	▲	△	▲
										M	▲	▲	△	△
										K	△	△	△	△
										N	△	△		▲
										S	△	△	▲	
										H	△	△	▲	

● Stock ○ Available Upon Order

Holders see page 88





Solid Cutting Tools For Micro Machining

SCIR

55 ° Threading

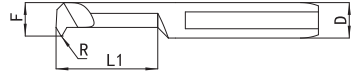
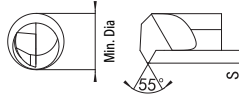
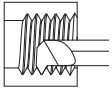
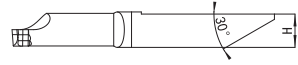

Unit: mm

Specification	F	S	L1	R	D	H	pitch	Threads	Min. Dia	NP5000	NP9000	NP1000	NU8000	
SCIR3-10L-A55	3.0	1.0	10	0.05	D4	3.7	0.5-1.0	48-24	3.1	○	●	○	●	
SCIR4-10L-A55	3.8	1.0	10	0.05	D4	3.7	0.5-1.0	48-24	4.0	○	●	○	●	
SCIR4-15L-A55	3.8	1.0	15	0.05	D4	3.7	0.5-1.0	48-24	4.0	○	●	○	●	
SCIR5-10L-A55	4.8	1.3	10	0.1	D5	4.7	0.5-1.25	48-20	5.0	○	●	○	●	
SCIR5-15L-A55	4.8	1.3	15	0.1	D5	4.7	0.5-1.25	48-20	5.0	○	●	○	●	
SCIR6-10L-A55	5.6	1.5	10	0.1	D6	5.7	0.5-1.5	48-16	6.0	○	●	○	●	
SCIR6-15L-A55	5.6	1.5	15	0.1	D6	5.7	0.5-1.5	48-16	6.0	○	●	○	●	
SCIR8-10L-A55	7.6	1.8	10	0.1	D8	7.7	1.0-2.0	48-14	8.0	○	●	○	●	
SCIR8-20L-A55	7.6	1.8	20	0.1	D8	7.7	1.0-2.0	48-14	8.0	○	●	○	●	
										P	△	▲	△	▲
										M	▲	▲	△	△
										K	△	△	△	△
										N	△	△		▲
										S	△	△	▲	
										H	△	△	▲	

● Stock ○ Available Upon Order

Holders see page 88



XSHB

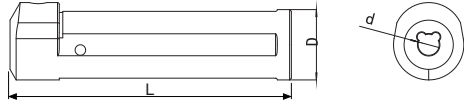

Unit: mm

Specification	D	d	L	Screw	Wrench	Connector
XSHB1204	12	4	65	M5	2.5	/
XSHB1205	12	5	65	M5	2.5	/
XSHB1206	12	6	65	M5	2.5	/
XSHB1208	12	8	65	M5	2.5	/
XSHB1604	16	4	75	M5	2.5	PT1/8
XSHB1605	16	5	75	M5	2.5	PT1/8
XSHB1606	16	6	75	M5	2.5	PT1/8
XSHB1608	16	8	75	M5	2.5	PT1/4
XSHB2004	20	4	80	M5	2.5	PT1/4
XSHB2005	20	5	80	M5	2.5	PT1/4
XSHB2006	20	6	80	M5	2.5	PT1/4
XSHB2008	20	8	80	M5	2.5	PT1/4
XSHB2204	22	4	80	M5	2.5	PT1/4
XSHB2205	22	5	80	M5	2.5	PT1/4
XSHB2206	22	6	80	M5	2.5	PT1/4
XSHB2208	22	8	80	M5	2.5	PT1/4
XSHB2504	25	4	100	M5	2.5	PT1/4
XSHB2505	25	5	100	M5	2.5	PT1/4
XSHB2506	25	6	100	M5	2.5	PT1/4
XSHB2508	25	8	100	M5	2.5	PT1/4



INDEX

All the workholding you need for Swiss turning can be ordered from one reliable source...

- Main Spindle Collets
- Sub Spindle Collets
- Guide Bushings
- Bar Loader Collets
- Custom Manufacturing



Dedicated teams and work cells manufacture to rigid specifications including material and heat treatment, with a process control that leads the industry. Every collet and guide bushing are inspected seriously before reaching the stock room.

Top-of-the-line machine tools and highly-skilled machinists provide exceptional productivity and accuracy. First-class machines produce custom collet shapes, stepped-holes and extended-nose collets.

Hardened & Ground Collets	90
Guide Bushings	92
Machine Builders' Reference	94
Cross-Reference Guide	103
FMB Bar Loader Collets	105
LNS Bar Loader Collets	106
Robobar Bar Loader Collets	107
Additional Products for Swiss-type Lathes	108
Custom Application Manufacturing	109

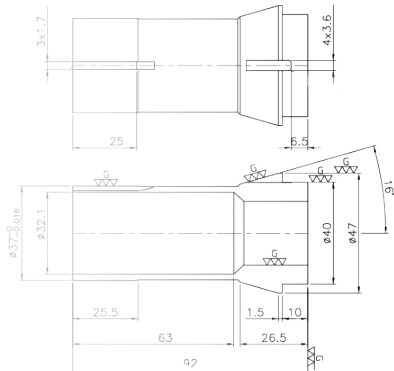
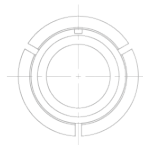



Main/Sub-spindle Collet

NICHE Swiss-type Collets are ground to precise size and TIR to meet precision machining requirements with a standard accuracy that rivals the industry.

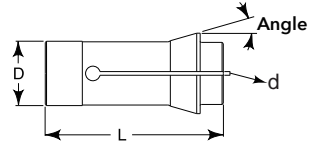

Machine Builder	Collet Model No.	Head Angle	D Bearing Dia.	L Ttl. Length
Tsugami	BS38	15° 15'	47.98	100
Tornos	F20-201	15°	19.99	54
Maier	F32-221	15°	32	75
Peterman, Strohm,Tornos, Tsugami, Citizen	TF8	15° 35'	8	41
Peterman, Strohm,Tornos, Citizen, Star	TF10	20°	10	47.50
Tornos	TF13	16°	13	64
Citizen, Maier, Star, Tornos, Tsugami	TF15	16°	15	64
Citizen, KSI, Hanwha,Tornos	TF16	16°	16	64
Maier, Star, Tornos, Tsugami, Traub	TF20	16°	19.99	67
Tsugami	TF24	15° 20'	23.79	62
Citizen, Hanwha, Hardinge,KSI, Maier, Star, Tornos, Tsugami, Methods	TF25	16°	25	77
Citizen, Hanwha, Hardinge,Star, Tornos, Tsugami, Methods	TF30	16°	30	80
Star, Tornos	TF34	16°	34	80.11
Citizen, Hanwha, KSI, Maier, Star, Tornos, Tsugami, Methods	TF37	16°	37	92
Citizen	TF37SP	16° 7'	36.98	92
Tsugami	TF43	16°	43	92
KSI	TF44	16.5°	44	92
Star	TF48	14° 50'	48	93.68
Tornos	0161	15°	30	65
Hardinge	0166	15°	32	65
Hardinge	S16-HMS	15° 40'	23.80	62
Hardinge	S20-HM	16°	28	77
Hardinge	S25-HM	16°	33	80
Hardinge	S25-HS	16°	30	80

Order Sample:

MC-TF25-d10

MC : Main-spindle Collet

Order Sample:

SC-TF25-d10

SC : Sub-spindle Collet

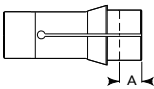

Flat-nose

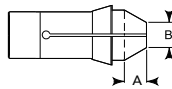

Taper-nose

Extended-nose Collets feature added nose length, flat or tapered, for doing Sub Spindle work or to compensate for tooling interferences. Please provide collet model (above), hole size, length of extension (A) required, and nose diameter (B) when ordering. The (B) dimension must be a minimum of 3.175 mm larger than the hole size.

See next page



Main/Sub-spindle Collet

NICHE Swiss-type Collets are ground to precise size and TIR to meet precision machining requirements with a standard accuracy that rivals the industry.

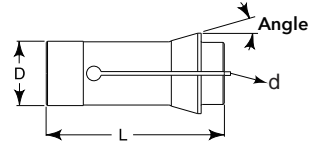

Min. - Max.

Machine Builder	Rated Collet Capacity			
	Round Smooth	Round Serrated	Hex	Square
Tsugami	0.20 - 39.67	-	6.35 - 34.14	6.35 - 27.76
Tornos	0.20 - 12.67	12.70 - 16.00	1.58 - 13.84	1.58 - 11.30
Maier	5.08 - 26.98	-	6.35 - 20.65	6.35 - 19.05
Peterman, Strohm, Tornos, Tsugami, Citizen	0.20 - 6.35	-	1.58 - 5.49	1.58 - 4.47
Peterman, Strohm, Tornos, Citizen, Star	0.20 - 7.14	-	1.58 - 6.17	1.58 - 5.03
Tornos	0.20 - 10.01	-	1.58 - 8.66	1.58 - 7.09
Citizen, Maier, Star, Tornos, Tsugami	0.20 - 12.67	12.70	1.58 - 10.99	1.58 - 8.96
Citizen, KSI, Hanwha, Tornos	0.20 - 12.67	12.70	1.58 - 10.99	1.58 - 8.96
Maier, Star, Tornos, Tsugami, Traub	0.20 - 12.67	12.70 - 15.87	1.58 - 13.74	1.58 - 11.22
Tsugami	0.20 - 12.67	12.70 - 17.48	1.58 - 15.11	1.58 - 12.34
Citizen, Hanwha, Hardinge, KSI, Maier, Star, Tornos, Tsugami, Methods	0.20 - 12.67	12.70 - 20.65	1.58 - 17.88	1.58 - 14.57
Citizen, Hanwha, Hardinge, Star, Tornos, Tsugami, Methods	0.20 - 12.67	12.70 - 25.40	2.36 - 21.99	2.36 - 17.95
Star, Tornos	0.20 - 12.67	12.70 - 28.57	2.36 - 24.73	2.36 - 20.19
Citizen, Hanwha, KSI, Maier, Star, Tornos, Tsugami, Methods	0.20 - 12.67	12.70 - 32.13	2.36 - 27.81	2.36 - 22.73
Citizen	0.20 - 31.75	-	2.36 - 27.48	2.36 - 22.43
Tsugami	0.20 - 38.00	-	6.35 - 32.92	6.35 - 26.87
KSI	5.08 - 37.85	-	6.35 - 31.75	6.35 - 22.23
Star	0.20 - 12.67	12.70 - 42.09	0.79 - 35.71	0.79 - 29.36
Tornos	0.20 - 12.67	12.70 - 25.40	2.36 - 22.00	2.36 - 17.96
Hardinge	0.20 - 12.67	12.70 - 28.57	6.35 - 24.61	6.35 - 20.24
Hardinge	0.20 - 17.47	-	1.58 - 15.11	1.58 - 12.34
Hardinge	0.20 - 12.67	12.70 - 20.65	3.17 - 17.88	3.17 - 14.57
Hardinge	0.20 - 12.67	12.70 - 26.19	2.36 - 22.65	2.36 - 18.51
Hardinge	0.20 - 25.4	-	2.36 - 21.99	2.36 - 17.95

Order Sample:

MC-TF25-d10

MC : Main-spindle Collet

Order Sample:

SC-TF25-d10

SC : Sub-spindle Collet

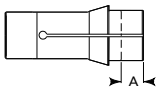

Flat-nose

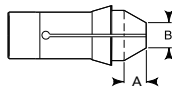

Taper-nose

Extended-nose Collets feature added nose length, flat or tapered, for doing Sub Spindle work or to compensate for tooling interferences.

Please provide collet model (above), hole size, length of extension (A) required, and nose diameter (B) when ordering. The (B) dimension must be a minimum of 3.175 mm larger than the hole size.



Swiss-type Guide Bushings

NICHE round Swiss Guide Bushings are Guide-lined to keep the stock clean and unmarked. Specials are available in hardened steel, Meehanite lining, angular & zig-zag slotted and extruded shapes.



Machine Builder	Fig.	Bushing Model No.	Head Angle	D Bearing Dia.	L Ttt. Length	T Thread Dia.
Citizen, Tornos, Peterman	2	0201	30°	24	61.21	M24 x 1
Citizen®, Hanwha, Hardinge, KSI, Maier, Tsugami, Star	1	CD25	10°	34	87.5	M34 x 1
Citizen, Peterman	1	PD4	16°	9	44	M8 x .75
Hardinge	1	S20HGB	16°	30	70	M28 x 1
Citizen, Hanwha, KSI, Maier, Tsugami, Bechler, Strohm, Tornos	2	SD125R	30°	18	60.20	M18 x 1
Star	1	SNC15	12° 30'	21	57.5	M18 x 1
Tsugami	1	STM38	16°	47.98	81.79	M46 x 1
Tornos	3	T-200	20° 5'	34	150.36	M32 x 1.5
Citizen, Tornos (CAM), Tsugami	1	TD7	16°	11	53.85	M10 x .75
Citizen, Star, Tornos, Bechler	1	TD10	16°	16	60.37	M14 x 1
Tsugami, Tornos	1	TD20	16°	22	68.22	M19 x 1
Maier, Star, Tsugami, Traub	1	TD20R	16°	22	68.22	M22 x 1
Tsugami, Tornos, Bechler	2	TD25	30°	28	82	M25 x 1
Maier, Hardinge, Star	1	TD25S	16°	28	82	M25 x 1
Citizen, Hanwha, KSI	1	TD25NS	16°	28	82	M25 x 1
Tsugami	1	TD26	16°	26	76.99	M25 x 1
Citizen, Maier, Tsugami, Tornos	2	TD32	20° 40'	41.29	81.79	M40 x 1
Hanwha, KSI, Star, Tornos	1	TD32S	16°	41.29	82.09	M40 x 1
KSI	3	TD38	16°	46	92	M45 x 1
Citizen, Tornos	2	TSD20	30°	32	71.24	M32 x 1
Hardinge, Tsugami	1	TSG-20R	16°	23	72	M22 x 1

Order Sample:
GB-TD25-d10
GB : Guide Bushings

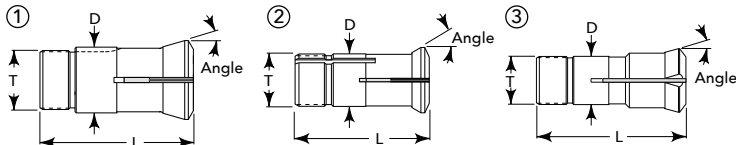



Swiss-type Guide Bushings

NICHE round Swiss Guide Bushings are Guide-lined to keep the stock clean and unmarked. Specials are available in hardened steel, Meehanite lining, angular & zig-zag slotted and extruded shapes.



Min. - Max.

Machine Builder	Guide-Lined	Hardened Steel	
	Round	Hexagon	Square
Citizen, Tornos, Peterman	1.58 - 15.87	3.17 - 13.74	3.17 - 11.22
Citizen®, Hanwha, Hardinge, KSI, Maier, Tsugami, Star	2.38 - 26.19	2.36 - 22.68	2.36 - 18.52
Citizen, Peterman	0.76 - 4.79	1.58 - 4.14	1.58 - 3.37
Hardinge	2.38 - 20.63	3.17 - 17.37	3.17 - 14.17
Citizen, Hanwha, KSI, Maier, Tsugami, Bechler, Strohm, Tornos	0.79 - 12.70	1.58 - 10.99	1.58 - 8.96
Star	0.79 - 14.28	3.17 - 12.36	3.17 - 10.08
Tsugami	6.35 - 40	6.35 - 32.89	6.35 - 26.87
Tornos	2.77 - 25.40	4.76 - 21.99	4.76 - 17.95
Citizen, Tornos (CAM), Tsugami	0.76 - 6.35	1.59 - 5.56	1.59 - 4.5
Citizen, Star, Tornos, Bechler	0.79 - 10.31	1.58 - 8.91	1.58 - 7.28
Tsugami, Tornos	1.58 - 13.49	1.58 - 11.68	1.58 - 9.52
Maier, Star, Tsugami, Traub	1.58 - 15.87	1.58 - 13.74	1.58 - 11.22
Tsugami, Tornos, Bechler	2.38 - 19.84	3.18 - 16.48	3.18 - 13.46
Maier, Hardinge, Star	2.38 - 19.84	3.17 - 16.48	3.17 - 13.46
Citizen, Hanwha, KSI	2.28 - 19.84	3.17 - 16.48	3.17 - 13.46
Tsugami	1.58 - 19.84	1.58 - 17.17	1.58 - 14.02
Citizen, Maier, Tsugami, Tornos	4.76 - 32.15	6.35 - 27.50	6.35 - 22.42
Hanwha, KSI, Star, Tornos	4.76 - 32.15	6.35 - 27.50	6.35 - 22.42
KSI	6.35 - 36.50	6.35 - 31.75	6.35 - 25.40
Citizen, Tornos	1.52 - 20.63	3.17 - 17.85	3.17 - 14.57
Hardinge, Tsugami	0.76 - 17.46	1.58 - 15.11	1.58 - 12.34

Order Sample:

GB-TD25-d10

GB : Guide Bushings

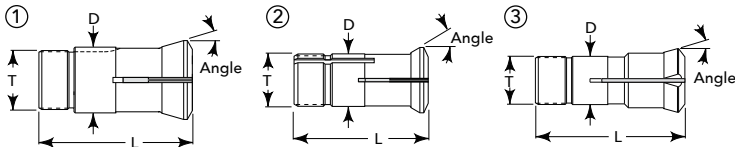



Citizen®

Machine Builders' Model No.	Main Spindle Collet	Guide Bushing	Adaptive	Sub Spindle Collet	Drill Sleeve Collet	Rotary Tool Collet
	Collet Model No.	Bushing Model No.	Guide Bushing	Collet Model No.	Collet Model No.	Collet Model No.
A16	TF20	O201	-	TF20	ER11	ER11
A20 / 20VI	TF25	TD25NS	97Z-1102	TF25	ER11 - ER16	ER16
A32	TF37SP	TD32	97Z-1653	TF37SP	ER16	ER16
B12	TF16	SD125R	-	-	TF8 - ER11	ER11
B12 I	TF16	SD125R	-	-	ER11	-
B12 II	TF16	SD125R	-	-	ER11	ER8
B12 V	TF16	SD125R	-	TF16	ER11	-
B12 VI	TF16	SD125R	-	TF16	ER11	ER8
BL12	BL12	-	-	-	ER11 - ER16	-
B20	TF25	TD25NS	-	TF25	TF8 - ER11	ER11
B20 I	TF25	TD25NS	-	-	ER16	-
B20 V	TF25	TD25NS	-	TF25	ER16	-
BL25	TF48	-	-	TF30	ER11 - ER16	ER11
C16	TF20	O201	-	TF20	ER11	ER11
C32	TF37SP	TD32	-	TF37SP	ER16	ER16
D10	TF15	TD10	-	-	TF8	-
D16	TF25	TP20	-	-	TF12	-
E16	TF25	O201	-	TF25	ER16	ER11
E16J	TF25	O201	-	TF25	TF8 - ER16	0136 - ER11
E216	TF25	O201	-	TF25	ER16	ER12 - ER16
E220	TF25	TSD20	-	TF25	ER16	ER12 - ER16
E225/25J	TF30	CD25	-	TF30	ER16	ER12 - ER16
E32	TF37SP	TD32	-	TF37SP	ER16	ER12 - ER16
E32 IV	TF37SP	TD32	-	TF37SP	ER16	ER11 - ER16
E32K	TF37	TD32	-	TF37	TF10 - ER16	ER12 - ER16
E232	TF37	TD32	-	TF37	ER16	ER12 - ER16
F10	TF15	TD10	-	-	TF8	-
F12	TF16	SD125R	-	TF16	TF8 - ER16	0136
F16	TF25	O201	-	TF25	TF8 - ER16	0136
F20	TF25	TSD20	-	TF25	TF10 - ER16	TF8 - ER16
F25	TF30	CD25	-	TF30	TF10 - ER16	TF8 - ER16
FL32	TF37SP	-	-	TF37SP	ER20 - ER25	ER11-16-20
FL42	TF48	-	-	TF48	-	-
G16	TF25	O201	-	-	TF8	-
G32	TF37SP	TD32	-	TF37SP	-	-
K16	TF20	O201	-	TF20	ER11 - ER16	ER11
L10	TF15	TD10	-	TF8	TF8	TF8
L16	TF25	O201	-	-	TF8 - ER16	-
L16 V	TF25	O201	-	TF25	TF8 - ER16	-
L16 VI	TF25	O201	-	TF25	TF8 - ER16	ER16
L20	TF25	TD25NS	-	TF25	ER16	ER16
L20 I / III	TF25	TD25NS	-	-	ER16	ER11 - ER16

See next page 



Citizen®

Machine Builders' Model No.	Main Spindle Collet	Guide Bushing	Adaptive	Sub Spindle Collet	Drill Sleeve Collet	Rotary Tool Collet
	Collet Model No.	Bushing Model No.	Guide Bushing	Collet Model No.	Collet Model No.	Collet Model No.
L20VII	TF25	TD25NS	–	TF25	ER16	ER11 - ER16
L25	TF30	CD25	–	TF30	ER16	ER16
L32	TF37SP	TD32	–	TF37SP	ER16	ER12 - ER16
L520/720	TF25	TD25NS	97Z-1102	TF25	ER16	ER16
M12	TF16	SD125R	–	TF16	ER11 - ER16	TF8 - ER16
M16	TF20	O201	–	TF20	ER11 - ER16	TF8 - ER11
M20	TF25	TD25NS	97Z-1102	TF25	TF8 - ER16	O136 - TF8
M20	TF25	TD25NS	97Z-1102	TF25	TF8 - ER16	ER11 - ER16
M32	TF37SP	TD32	97Z-1653	TF37SP	ER16	ER11 - ER16
R04	TF8	PD4	–	TF8	ER8	ER8
R07	TF15	TD7	–	TF15	ER8	ER8

Hanwha

Machine Builders' Model No.	Main Spindle Collet	Guide Bushing	Sub Spindle Collet	Tool Holder Collet
	Collet Model No.	Bushing Model No.	Collet Model No.	Collet Model No.
HANEX 25	TF30	CD25	TF30	ER11 ER16
ML12S	TF16	SD125R	TF16	ER11 ER11
ML20H(18H)	TF25	TD25-NS	TF25	ER11 ER16
ML20S(18S)	TF25	TD25-NS	TF25	ER11 ER16
ML26H	TF30	CD25	TF30	ER11 ER16
ML26S	TF30	CD25	TF30	ER11 ER16
SL12S/H	TF16	SD125R	TF16	ER11 ER16
SL12SE	TF16	SD125R	TF16	ER11 ER16
SL20H	TF25	TD25-NS	TF25	ER11 ER16
SL20HP	TF25	TD25-NS	TF25	ER11 ER16
SL20S	TF25	TD25-NS	TF25	ER11 ER16
SL26H	TF30	CD25	TF30	ER11 ER16
SL26HP	TF30	CD25	TF30	ER11 ER16
SL26S	TF30	CD25	TF30	ER11 ER16
SL32HP	TF37	TD32S	TF37	ER16 ER16
SL35HP	F40-SL35	TD35	F40-SL35	ER11 ER16
SL35	F40-SL35	TD45	F40-SL35	ER11 ER16
XP16	TF22	TD20R-16	TF22	ER11 ER16
XD20	TF25	TD25-NS	TF25	ER11 ER16



KSI

Machine Builders' Model No.	Main Spindle Collet Collet Model No.	Guide Bushing Bushing Model	Sub Spindle Collet Collet Model	Tool Holder Collet Collet Model
SA12	TF16	SD125R	TF16	ER11
SA20/SM20	TF25	TD25-NS	TF25	ER16
SA26	F32-221	CD25	F32-221	ER16
SA32	TF37	TD32S	TF37	ER16
SA38	TF44	TD38	TF37	ER16
SQC20	TF25	TD25-NS	TF25	ER16
SQC32	TF44	TD32S	TF37	ER16
SQC38	TF48	TD38	TF44	ER16

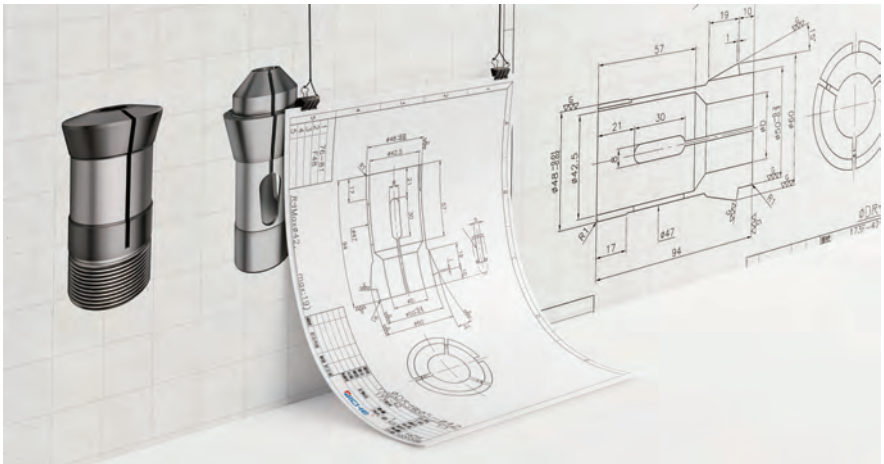



Maier

Machine Builders' Model No.	Main Spindle Collet	Guide Bushing	Sub Spindle Collet	Tool Holder Collet
	Collet Model No.	Bushing Model No.	Collet Model No.	Collet Model No.
ML-12A/12B	TF15	SD125R	TF15	ER11
ML-12C/12D	TF15	SD125R	TF15	ER11
ML-16A/16B	TF20	TD20R	TF20	ER11
ML-16C/16D	TF20	TD20R	TF20	ER11
ML-20A/20B	TF25	TD25S	TF25	ER16
ML-20C/20D	TF25	TD25S	TF25	ER16
ML-20E	TF25	TD25S	TF25	ER16
ML-26A/26B	F32-221	CD25	F32-221	ER16
ML-26C/26D	F32-221	CD25	F32-221	ER16
ML-26E	F32-221	CD25	F32-221	ER16
ML-32A/32B	TF37	TD32S	TF37	ER16
ML-32C/32D	TF37	TD32S	TF37	ER16
ML-32E	TF37	TD32S	TF37	ER16
MLK-32	TF37	TD32S	TF37	ER16

Star

Machine Builders' Model No.	Main Spindle Collet	Guide Bushing	Sub Spindle Collet	Tool Holder Collet		Attachment Collet
	Collet Model No.	Bushing Model No.	Collet Model No.	Collet Model No.		Collet Model No.
ECAS 12/16	TF20	TD20R	TF20	ER11	ER16	-
ECAS 20	TF25	TD25S	TF25	ER11	ER16	-
ECAS 32	TF37	TD32S	TF37	ER11	ER16	-
JNC10	TF15	TD10	-	-	-	TF10
JNC16	TF20	TD20R-SNC15	-	-	-	TF10
JNC25/32	TF37	TD32S	-	ER11	ER16	-
KNC16/20B	TF25	TD25S	TF25	ER11	ER16	-
KNC20	TF25	TD25S	TF25	ER11	ER16	-
KNC25/32B	TF37	TD32S	TF37	ER11	ER16	-
KNC32	TF37	TD32S	TF37	ER11	ER16	-
KJR16B	TF20	TD20R	TF20	ER11	ER16	-
KJR25/25B	TF30	CD25	TF30	ER11	ER16	-
MAF42	TF-48	-	-	-	-	-
RNC10/10B	TF15	TD10	TF15	ER11	ER16	-
RNC16 & II	TF20	TD20R	-	ER11	ER16	-
RNC16B & II	TF20	TD20R	TF15-TF20	ER11	ER16	-
SA12	TF20	TD20R	TF20	-	-	-
SA16/16R	TF20	TD20R	TF20	ER11	ER16	-
SB16/16S	TF20	TD20R	TF20	ER11	ER16	-

See next page 



Star

Machine Builders' Model No.	Main Spindle Collet	Guide Bushing	Sub Spindle Collet	Tool Holder Collet		Attachment Collet
	Collet Model No.	Bushing Model No.	Collet Model No.	Collet Model No.		Collet Model No.
SE12	TF20	SNC15	–	ER11	ER16	–
SE16	TF20	TD20R	–	ER11	ER16	–
SH7	TF15	SW7	–	ER11	ER16	–
SH12	TF20	TD20R	–	ER11	ER16	–
SH16	TF20	TD20R	–	ER11	ER16	–
SI 12/12C	TF20	SNC15	TF20	ER11	ER16	–
SNC10DX	TF15	TD10	–	–	–	TF10
SNC15DX	TF20	TD20R	–	–	–	TF10
SNC25DX	TF34	TD32S	–	–	–	TF10
SNC25DX	TF34	CD25	–	–	–	F18-579
SR10J	TF15	TD10	TF15	–	–	TF10
SR16/16R	TF20	TD20R	TF20	ER11	ER16	–
SR20/20R	TF25	TD25S	TF25	ER11	ER16	–
20RII/20RS	TF25	TD25S	TF25	ER11	ER16	–
SR32/SR32J	TF37	TD32S	TF37	–	–	–
SST16	TF20	TD20R	TF10-TF20	ER11	ER16	–
STM32	TF37	TD32S	–	–	–	TF10-TF15
STM32	TF37	TD32S	–	–	–	F18-579
STM38	TF48	–	–	–	–	TF10-TF15
STM38	same as B42	–	–	–	–	F18-579
SV12	TF20	TD20R	–	–	–	–
SV20	TF25	TD25S	TF25	ER11-16-20	–	–
SV32	TF37	TD32S	TF37	–	–	–
SV32J/32J II	TF37	TD32S	TF37	–	–	–
SW7	TF15	TD10-SW7	TF15	ER11	ER11	–
VNC12	TF20	TD20R	TF15	ER11	ER16	–
VNC20	TF25	TD25S	TF20	ER11	ER16	–
VNC32	TF37	TD32S	TF30	ER11	ER16	–



Tornos - CNC

Machine Builders' Model No.	Main Spindle Collet	Guide Bushing	Sub Spindle Collet	Drill Sleeve Collet	Cross Drill Collet
	Collet Model No.	Bushing Model No.	Collet Model No.	Collet Model No.	Collet Model No.
DECO 2000 10	TF13	TD10	TF13	ER11 - ER12	ER11 - ER12
DECO 2000 13	F20-201	0201	TF20-201	ER11 - ER12	ER11 - ER12
DECO 2000 20	TF25	TD25-167	TF25	ER11 - ER12	ER11 - ER12
DECO 2000 25/32	TF37	TD32S	TF37	ER11 - ER12	ER11 - ER12
DECO 2000 1"	0161	CD25	0161	ER11 - ER12	ER11 - ER12
Elector16	F20-201	0201	-	AE4402	WJ#3
ENC16	F20-201	0201	F20-201	-	-
ENC162	TF15-F20-201	0201	-	ER16 ER25	WJ#3
ENC164	TF15-F20-201	0201	TF15-F20-201	ER16 - ER25	WJ#3
ENC167	TF25	TD25-167	TF25	ER12 -16-20	ER12-16-20
ENC74	TF13	TD10	TF13	ER12	ER12
ENC262	TF25-0161	T200	TF25-0161	ER16 - ER25	ER25
ENC264	TF25-0161	T200	TF25-0161	ER16 - ER25	ER25
TOP-100	TF16	TD10TXP	TF13	ER16 - ER25	ER12 - ER25
TOP-100	TF16	TD18TXP	TF13	ER16 - ER25	ER12 - ER25
TOP-200	0161	T200	TF25-0161	ER16-20-25	ER20 - ER25
TMB26	F32-221	SD255-36	-	ER25 - ER32	ER20
M10	TF15	TD10-125	-	-	-
M20	TF25	TD25TS	-	-	-
M25/28	TF34	TD25TS	-	-	-
MR32	TF37	TD32	-	-	-
R10	TF15	TD10-125	-	-	-
R125	TF16	TD10-125	-	-	-
R20/RR20	TF25	TD25TS	-	-	-

NexTurn

Machine Builders' Model No.	Main Spindle Collet	Guide Bushing	Sub Spindle Collet	Drill Sleeve Collet	Cross Drill Collet
	Collet Model No.	Bushing Model No.	Collet Model No.	Collet Model No.	Collet Model No.
SA12/12A	TF16	SD125R	TF16	ER11	ER11
SA18A	TF25	TD25NS	TF25	ER11 - ER16	ER11 - ER16
SA20/20E	TF25	TD25NS	TF25	ER16	ER16
SA26/26E	F32-221	CD25	F32-221	ER16	ER16
SA32	TF37	TD32S	TF37	ER16	ER16
SA38	TF44	TD38	TF37-TF44	ER16	ER16



Traub

Machine Builders' Model No.	Main Spindle Collet	Guide Bushing	Sub Spindle Collet	Drill Sleeve Collet	Cross Drill Collet
	Collet Model No.	Bushing Model No.	Collet Model No.	Collet Model No.	Collet Model No.
TNL-12	TF16	TRB468	TF16	R11 - ER16	ER11 - ER16
TNL-16G	TF20	TD20R	TF20	ER11 - ER16	ER11 - ER16
TNL-16G	0156	TD25S	0156	ER11 - ER16	ER11 - ER16
TNL-26	TF30	TRB761	TF30	ER11 - ER16	ER11 - ER16

Tsugami

Machine Builders' Model No.	Main Spindle Collet	Guide Bushing	Sub-spindle Collet	Tool Holder Collet				
	Collet Model No.	Bushing Model No.	Collet Model No.	Cross Dill	Face Dill	Hi-Speed Drill	Cross Tap	Vertical Drill
BA26	0166	TD33	0166	ER16	ER16	–	–	–
BE12/12 III	TF24	TSG20R	TF24	ER11 - ER16	ER11 - ER16	–	–	–
BE19	TF25	TD25	TF25	ER11 - ER16	ER11	–	–	–
B007	TF10	TD7	TF10	–	–	–	–	–
BE20 III/20V	TF25	TD25	TF25	ER16 - ER20	–	–	–	–
BF20	TF25	TD25	TF25	–	–	–	–	–
BH20	TF25	TD25	TF25	ER16 - ER20	–	–	–	–
BS12/B012	TF24	TSG20R	TF24	–	ER11	–	–	–
BS19/BS20	TF25	TD25	TF25	–	–	–	–	–
BS20B/C	TF25	TD25	TF25	ER16	ER16	–	–	–
BS20V/SS20	TF25	TD25	TF25	ER16 - ER20	–	–	–	–
BS26/BU26	0166	CD25	0166	–	–	–	–	–
BS32	BS32C	BS32B	BS32C	–	–	–	–	–
BU20	TF25	TD25	TF25	–	ER11 - ER16	–	–	–
BW07	TF10	TD7	TF10	–	ER11	–	–	–
BW12/BU12	TF24	TSG20R	TF24	–	ER11 - ER16	–	–	–
BX18/ BZ18	TF24	TSG20R	TF24	ER11	ER11	–	–	–
MB3516C	1717	–	–	–	–	–	–	–
MB38	16C	–	BS38	–	–	–	–	–
MU26S/SY	0166	TD25	0166	various	various	various	various	various
MU38/BU38	TF43	STM38	BS38	16C	1717	–	–	–
NP11	TF15	SD125R	TF15	–	ER12	–	–	–
NP16-16 II	TF20	TD25	TF20	ER12	ER12	TF8-4701	TF8-4701	ER16

See next page





Tsugami

Machine Builders' Model No.	Main Spindle Collet	Guide Bushing	Sub-spindle Collet	Tool Holder Collet				
	Collet Model No.	Bushing Model No.	Collet Model No.	Cross Drill	Face Drill	Hi-Speed Drill	Cross Tap	Vertical Drill
NP17	TF24	TSG20R	TF24	ER12	ER12	-	-	-
NP20-20 I	TF25	TD25	TF25	ER16	ER16	-	-	ER16 - ER20
NP20 II/20 III	TF25	TD25	TF25	ER16	ER16	-	-	ER16 - ER20
NP32	TF37	TD32	-	ER16	ER16	-	-	ER16 - ER20
NP32 II/32 III	TF37	TD32	TF37	ER16	ER16	-	-	ER16 - ER20
NT11-11S	TF15	SD125R	-	-	-	-	-	-
NT12	TF20	TD20-TD20R	-	ER12	ER12	TF8-4701	TF8-4701	ER16
NT16 II/16 III	TF20	TD25	-	ER12	ER12	TF8-4701	TF8-4701	ER12
NT17/17S	TF24	TSG20R	-	-	-	-	-	-
NT20	TF25	TD25	-	ER16	ER16	-	-	ER16 - ER20
NT20, I, II & III	TF25	TD25	TF25	ER16	ER16	-	-	ER16 - ER20
NT25	TF37	TD32	-	ER16	ER16	-	-	ER16 - ER20
NT32, II & III	TF37	TD32	-	ER16	ER16	-	-	ER16 - ER20
S16D, H, P	TF24	TSG20R	TF24	ER12	ER12	-	-	-
S20	TF25	TD25	-	-	-	-	-	-
S20D & H	TF25	TD25	TF25	ER16	ER16	-	-	-
S20P	TF25	TD25	TF25	-	ER16	-	-	-
S25	TF30	CD35	TF30	-	-	-	-	-
S25D, H, P	0166	CD25	0166	ER16	ER16	-	-	-
SS20	TF25	TD25	TF25	ER16 - ER20	-	-	-	-
SS32	TF37	TD32	TF37	ER16 - ER20	ER16	-	-	-
SX20A	TF25	TD25	TF25	-	ER16	-	-	-
SX20B/20C	TF25	TD25	TF25	ER16	ER16	-	-	-
SX25	0166	CD25	0166	ER16	ER16	-	-	-
SX26	0166	CD25	0166	ER16 ER20	ER16	-	-	-
600	TF20	TD25	-	-	-	-	-	-
600P	TF20	TD25	TF20	-	-	-	-	-
S520/532	TF25	TD25	TF25	MPC16-20	-	-	-	-
TMU1	TF43	TD38	BS38	various	various	various	various	various



Bechler

Machine Builder Model No.	Collet Collet Model No.	Draw Bushing Bushing Model No.
A/AS/AR/10	OA	TD10
A/AS/AR/10	OA	SD125
A/AS/AR/10	OA	SD125R
A/AS/AR/10	OA	BD10
B-BR-20	OA	TD25

Tornos

Machine Builder Model No.		Steel Collet Model No.	Guide Bushing Bushing Model No.
Main Spindle	Attachments	Model No.	Bushing Model No.
-	M7 • R10-R125	TF6	-
-	R10-R125	TF7	-
M4	M7 • R10-R125	TF8	TD4
M4	M7 • R10-R125	TF8	TSD4
M7	M15 • R16	TF10	TD7
M7	M15 • R16	TF10	TSD7
M7	M15 • R16-20	TF12	-
MS7	M7 • CT.HSK.	TF13	-
M20	-	TF25	TD25
M20	-	TF25	TSD20
M10	-	TF25	TD10
M10	-	TF25	SD125R-16
M15	-	TF20	TD20
M15	-	TF20	TSD15
M25/28	-	TF34	TD25
MR32	-	TF37	TD32
R10	-	TF15	TD10
R10	-	TF15	SD125R
R10	-	TF15	SD125R-16
R16	-	TF20	TD20
R16	-	TF20	TSD15
R20	-	TF25	TD25
R20	-	TF25	TD20
RR20	-	TF25	TD25
RR20	-	TF25	TD20
RR20	-	TF25	TSD20
R125	-	TF16	TD10
R125	-	TF16	SD125R
R125	M20-25-28, MR32	TF16	SD125R-16

Strohm

Machine Builder Model No.		Collet-RD Collet Model No.	Guide Bushing Bushing Model No.
Main Spindle	Attachments	Collet Model No.	Bushing Model No.
-	M45	TF5	-
-	M125	TF5	-
M45	-	-	TSD4
M45	M105	TF8	0100
-	M125	TF8	-
M75	-	TF10	TSD7
M125	M205	TF15	SD125R
M105	M255	TF15	-
M125	-	TF15R	SD125R-16
M205	-	TF25	SD205
M255	-	TF30	SD255

Methods

Machine Builder Model No.	Collet-RD Collet Model No.	Guide Bushing Bushing Model No.
SS20	TF25	TSD20
SS25	TF30	TD25
SS32	TF37	TD32

Peterman

Machine Builder Model No.		Collet Collet Model No.	Guide Bushing Collet Model No.
Main Spindle	Attachments	Collet Model No.	Collet Model No.
-	P4	0131	0100
-	P4	-	PD4
P0-P3	P7	0136	-
P4	P7R	TF8	-
P7	P10	TF10	TD7
-	P16	TF10	-
P7R	-	0146	-
P10	P16	0147	-
-	P25	0147	-
P10R	P16	0151	-
-	P25	0151	-
P16	-	0152	0201
2A	-	0156	-
P25	-	0166	0200



Guide Bushings

Hardinge® Model Number	Southwick & meister Model Number	KEB(MasWerks) Model Number	Schaublin Model Number
CD25	CD25	MCD25	-
PD4	PD4	-	-
S20HGB	-	-	-
SD125R	SD125R	MD125R	-
SNC15	SNC15	MD15	-
STM38	STM38	MD38S	-
SW7	SW7	MD7	-
T-200	T-200	-	-
TD7	TD7	MD7	-
TD10	TD10	MD10	-
TD10TXP	TD1-TXP	-	-
TD20	TD20	MD20	-
TD20R	TD20R	MD20R	-
TD25	TD25	MD25TS	-
TD25-167	TD25-167	-	-
TD25S	TD25S (Star)	MD25	-
TD25NS	TD25NS	MD25	-
TD26	TD26	-	-
TD32	TD32	MD32	-
TD32S	TD32S	MD32S	-
TD38	TD38	-	-
TSD20	TSD20	MSD20	-
TSG-20R	TSG-20R	MD20RTS	-
O201	O201	MDO201	-
TP20	TP20	MD20	-

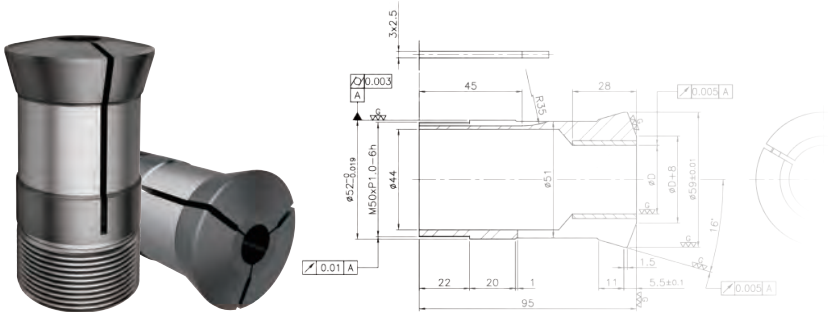



FMB Bar Loader Collets

NICHE Bar Loader Collets are engineered for wear resistance, thus requiring fewer collet replacements. D-style collets are supplied with a cross hole for pin mounting and are available in fractional and decimal sizes.

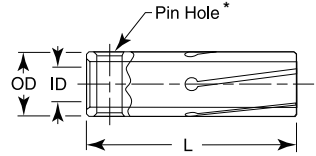

Style-D

Machine Builder Model No.	OD	ID	L	Collet Range	Increment
FMB-5D	5.00	M4 x .7 THD	28.00	1.27 - 3.00	0.025
FMB-7D	7.00	M5 x .8 THD	28.00	1.27 - 5.00	0.025
FMB-10D	10.00	7.00	40.00	1.27 - 8.00	0.025
FMB-12D	12.00	8.00	40.00	2.291 - 0.01	0.025
FMB-15D	15.00	11.00	40.00	2.54 - 13.00	0.025
FMB-18D/15	18.00	11.00	40.00	5.08 - 16.00	0.025
FMB-18D/NS	18.00	11.00	65.00	5.08 - 16.00	0.025
FMB-18D	18.00	14.00	65.00	2.36 - 16.00	0.025
FMB-20D	20.00	14.00	65.00	2.54 - 18.01	0.025
FMB-22D/20	22.00	14.00	65.00	5.08 - 19.99	0.025
FMB-25D	25.00	20.00	65.00	5.08 - 23.01	0.025
FMB-28D	28.00	20.00	65.00	12.7 - 26.01	0.025

DL-style Collets all have 20mm rear bore for mounting and are secured with two set screws. This common mounting feature allows interchanging the collets between different units. Available in fractional and decimal sizes.

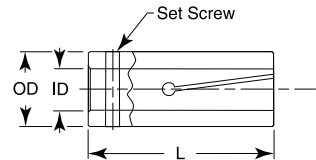

Style-DL

Note: Order hole capacity is equal to actual size with a - 0.10 mm range and has no over-range capacity. Therefore, the order hole size cannot be smaller than the bar stock.

Machine Builder Model No.	OD	ID	L	Collet Range	Increment	Set Screw
FMB-25DL	25.00	20.00	90.00	4.93 - 21.82	0.025	6 x 1 x 6
FMB-30DL	30.00	20.00	90.00	12.70 - 27.00	0.025	6 x 1 x 6
FMB-32DL	32.00	20.00	90.00	15.88 - 28.30	0.025	6 x 1 x 6
FMB-34DL	34.00	20.00	90.00	19.05 - 30.94	0.025	6 x 1 x 6
FMB-36DL	36.00	20.00	90.00	22.23 - 32.94	0.025	8 x 1.25 x 8
FMB-38DL	38.00	20.00	90.00	25.40 - 35.00	0.025	8 x 1.25 x 8
FMB-42DL	42.00	20.00	90.00	31.75 - 38.89	0.025	8 x 1.25 x 10
FMB-45DL	45.00	20.00	90.00	34.93 - 41.66	0.025	8 x 1.25 x 10
FMB-50DL	50.00	20.00	90.00	38.10 - 46.81	0.025	8 x 1.25 x 16
FMB-60DL	60.00	20.00	90.00	44.45 - 57.00	0.025	8 x 1.25 x 20
FMB-65DL	65.00	20.00	90.00	50.80 - 61.98	0.025	8 x 1.25 x 20
FMB-70DL	70.00	20.00	90.00	55.55 - 67.01	0.025	8 x 1.25 x 20



NICHE Bar Loader Collets are engineered for wear resistance, thus requiring fewer collet replacements. D-style collets are supplied with a cross hole for pin mounting and are available in fractional and decimal sizes.

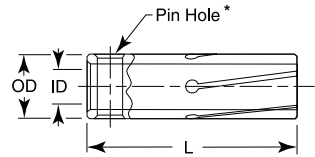

Style-D

Machine Builder Model No.	OD	ID	L	Collet Range	Increment	Cross Drill
LNS-LN6D	6.00	M4 x .7mm THD	30.00	1.98 - 3.99	0.025	-
LNS-LN7D	7.00	M5 x .8mm THD	37.00	3.00 - 5.00	0.025	-
LNS-LN10D	10.00	M5 x .8mm THD	37.00	5.00 - 8.00	0.025	-
LNS-10D	10.00	7.00	40.00	5.00 - 8.00	0.025	4.20
LNS-12D	12.00	8.00	40.00	2.54 - 10.01	0.025	4.20
LNS-13D	13.00	8.00	40.00	6.00 - 11.00	0.025	4.20
LNS-14D	14.00	8.00	40.00	8.00 - 11.99	0.025	4.20
LNS-15D	15.00	11.00	40.00	9.98 - 13.00	0.025	6.20
LNS-16D	16.00	11.00	40.00	9.98 - 14.00	0.025	6.20
LNS-18D/15	18.00	11.00	40.00	12.98 - 16.00	0.025	6.20
LNS-19D	19.00	11.00	40.00	12.98 - 16.99	0.025	6.20
LNS-20D	20.00	14.00	65.00	12.98 - 18.01	0.025	8.20
LNS-21D	21.00	14.00	65.00	14.00 - 19.00	0.025	8.20
LNS-22D/20	22.00	14.00	65.00	15.88 - 19.99	0.025	8.20
LNS-25D	25.00	20.00	65.00	17.98 - 23.01	0.025	8.20
LNS-27D	27.00	20.00	65.00	21.01 - 24.99	0.025	8.20
LNS-28D	28.00	20.00	65.00	22.50 - 26.01	0.025	8.20
LNS-30D	30.00	20.00	65.00	24.99 - 27.99	0.025	8.20
LNS-32D	32.00	20.00	65.00	24.99 - 30.00	0.025	8.20

DL-style Collets all have 20mm rear bore for mounting and are secured with two set screws. This common mounting feature allows interchanging the collets between different units. Available in fractional and decimal sizes.

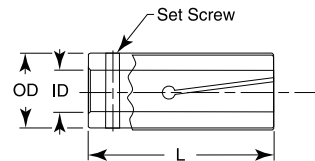

Note: Order hole capacity is equal to actual size with a - 0.10 mm range and has no over-range capacity. Therefore, the order hole size cannot be smaller than the bar stock.

Style-DL

Machine Builder Model No.	OD	ID	L	Collet Range	Increment	Set Screw
LNS-34DL	34.00	20.00	90.00	27.99 - 30.99	0.025	6 x 1.00
LNS-36DL	36.00	20.00	90.00	30.00 - 32.99	0.025	8 x 1.25
LNS-38DL	38.00	20.00	90.00	32.00 - 35.00	0.025	8 x 1.25
LNS-40DL	40.00	20.00	90.00	34.01 - 37.01	0.025	8 x 1.25
LNS-42DL	42.00	20.00	90.00	35.99 - 38.99	0.025	8 x 1.25



Robobar Bar Loader Collets

NICHE Bar Loader Collets are engineered for wear resistance, thus requiring fewer collet replacements. D-style collets are supplied with a cross hole for pin mounting and are available in fractional and decimal sizes.

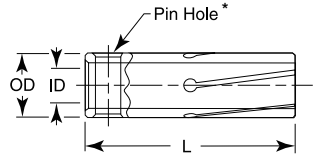

Robobar

Machine Builder Model No.	OD	ID	L	Collet Range	Increment	Tornos
RBB-5D	5.00	M4 x .7mm THD	28.00	1.27 - 3.00	0.025	26 - 5.5
RBB-7D	7.00	M5 x .8mm THD	28.00	1.27 - 5.00	0.025	26 - 7.5
RBB-10D	10.00	7.00	40.00	1.27 - 8.00	0.025	26 - 10.5
RBB-12D	12.00	8.00	40.00	1.27 - 10.01	0.025	26 - 12.5
RBB-15D	15.00	11.00	40.00	2.29 - 13.00	0.025	26 - 16
RBB-18D	18.00	14.00	65.00	2.36 - 16.00	0.025	-
RBB-20D	20.00	14.00	65.00	2.54 - 18.01	0.025	26 - 21
RBB-25D	25.00	20.00	65.00	5.08 - 23.01	0.025	26 - 26
RBB-28D	28.00	20.00	65.00	12.7 - 26.01	0.025	-

Other Bar Loader Collets available on request.

Note: Millimeters in parentheses ()

All "D" style collets have a pin hole for mounting. The bar loader collet mounting stud on the 25D collet must be altered when using 12.7 mm diameter stock and smaller.





Hardinge offers a complete line of tool holders, tap holders, toolholder collets, tap collets and bushings that can be used on your Swiss-type lathe. We offer reliable and economical solutions for back-end, sub-spindle and end-working slides. For more information request brochure 2351.

ERTCSP Tap Collets are designed for use in a floating tap holder. They are multi-split with more shank bearing surface than ER-DR collets. The bore is the exact size of the shank with a square broached hole to eliminate tap slippage.



ERTC Floating Tap Collets are designed for a specific tap shank size to be used in combination with tool-tap holders. These collets are not used in floating tap holders.



Floating Tap Holders for standard ER (split) collets.

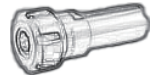

Rigid Tap Holders for floating tap collets.

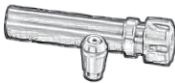

Standard Round Shank ER Collet Holders

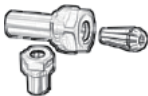

HDB Hardened & Ground Split Bushings help to eliminate interference common to ER tool holders. Knurled shoulder for easy installation and removal.

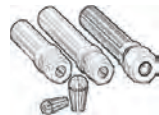



For generations, NICHE "Specials" have been the choice of experienced machinists, manufacturing engineers and forward-thinking manufacturers around the world:

Bearing Relief

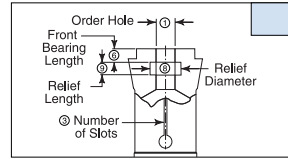

Chamfer - Depth

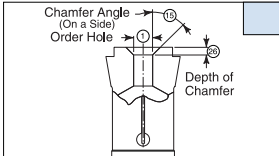

Chamfer - Diameter

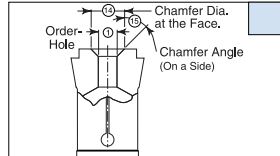

Radius

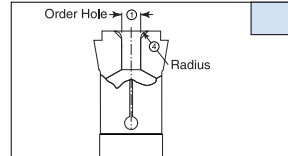

Special Bearing Length

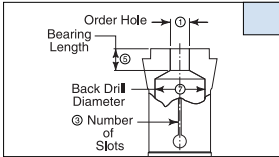

Eccentric Step - Aux. Off Center

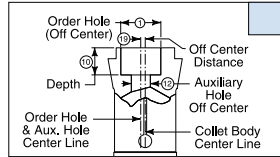

Eccentric Step - Aux. On Center

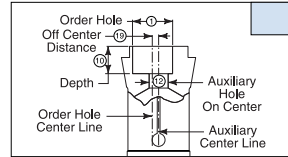

Single-Stepped

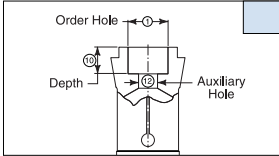

Double-Stepped

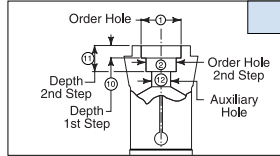

Threaded Order Hole

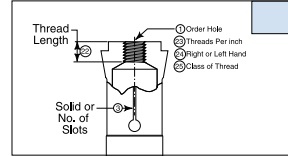

Extended Nose - Straight

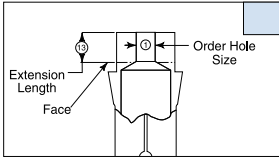

Extended Nose - Tapered

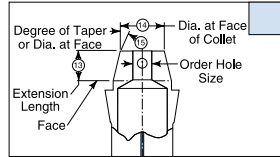

Angular Slotted

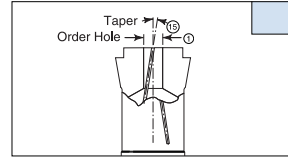

Taper - Regular

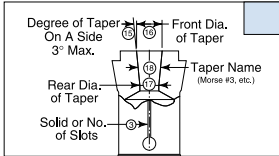

Taper - Reverse

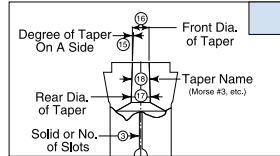

Zig-Zag Slots

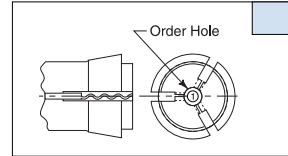



ADDRESS

ROOM 14-2, NO. 88 XIANGYE STR., ZHENHAI,
NINGBO CHINA, 315202

GET IN TOUCH

PHONE: **+86 574 8659 2189**

FAX: **+86 574 8659 3892**

NTTOOLS2017@GMAIL.COM

WWW.NICHE-TOOL.COM